

# CB-2 UMA LOGIC SCHEMATICS

- 1.TITLE PAGE
- 2.EC HISTORY
- 3.CPU(1/16) : DDI/EDP
- 4.CPU(2/16) : MISC/JTAG
- 5.CPU(3/16) : DDR3L CHANNEL-A
- 6.CPU(4/16) : DDR3L CHANNEL-B
- 7.CPU(5/16) : RTC/HDA/SATA/JTAG
- 8.CPU(6/16) : CLOCK SIGNALS
- 9.CPU(7/16) : LPC/SPI/SMBUS/C-LINK
- 10.CPU(8/16) : SYSTEM PM
- 11.CPU(9/16) : LCD/PCI/DDI CONTROL
- 12.CPU(10/16) : GPIO/CPU/MISC/LPIO
- 13.CPU(11/16) : PCIE/USB
- 14.CPU(12/16) : POWER
- 15.CPU(13/16) : POWER
- 16.CPU(14/16) : GND
- 17.CPU(15/16) : NCTF
- 18.CPU(16/16) : CFG/RESERVED
- 19.DDI-VGA CONVERTER
- 20.BLANK
- 21.XDP CONNECTOR
- 22.RTC BATTERY
- 23.SPI FLASH
- 24.DDR3L SO DIMM CHANNEL-A
- 25.BLANK
- 26.DDR3L SO DIMM CHANNEL-B
- 27.BLANK
- 28.BLANK
- 29.BLANK
- 30.BLANK
- 31.BLANK
- 32.BLANK
- 33.BLANK
- 34.BLANK
- 35.BLANK
- 36.BLANK
- 37.BLANK
- 38.LCD CONNECTOR
- 39.BLANK
- 40.EXT CRT INTERFACE
- 41.DISPLAY PORT CONNECTOR
- 42.BLANK
- 43.SATA HDD CONN
- 44.BLANK
- 45.USB POWER/CONN
- 46.GBE CLARKVILLE
- 47.GBE LAN SWITCH
- 48.GBE MAGNETICS
- 49.RJ45 CONNECTOR
- 50.PCIE MINI CARD SLOT
- 51.MEDIA CARD CONTROLLER
- 52.MEDIA CARD ITERFACE
- 53.SMART CARD I/F
- 54.AUDIO ALC292-GR
- 55.AUDIO CONNECTOR
- 56.AUDIO JACK SENSE
- 57.AUDIO EXT MIC I/F
- 58.AUDIO SPEAKER
- 59.AUDIO BEEP
- 60.DOCKING CONNECTOR
- 61.MEC1633L(1/3)
- 62.MEC1633L(2/3)
- 63.MEC1633L(3/3)
- 64.KEYBOARD CONNECTOR
- 65.TOUCH PAD CONNECTOR
- 66.BLANK
- 67.FAN CONNECTOR
- 68.G-SNESOR
- 69.TPM
- 70.EEPROM/SMBUS SW
- 71.THINK ENGINE(1/2)
- 72.THINK ENGINE(2/2)
- 73.DC-IN
- 74.BATTERY INPUT
- 75.BATTERY CHARGER(BQ24760T)
- 76.CHARGER SELECTOR
- 77.BATTERY MONITOR
- 78.DC/DC VCC5M/VCC3M(TPS51220A)
- 79.DC/DC VCCCPUCORE(VT1328M)
- 80.DC/DC VCCCPUCORE(VT1334S)
- 81.BLANK
- 82.VCCCPUCORE DECOUPLING
- 83.BLANK
- 84.BLANK
- 85.DC/DC VCC1R05AMT(VT382B)
- 86.DC/DC VCC1R35A(VT387B)
- 87.DC/DC VCC0R675B(TPS51200)
- 88.BLANK
- 89.BLANK
- 90.BLANK
- 91.BLANK
- 92.DC/DC VCC1R5B(BU15TD2WNV)
- 93.LOAD SW PCH SUS
- 94.LOAD SW LAN
- 95.BLANK
- 96.LOAD SW B
- 97.BLANK
- 98.LOAD SW WWAN & WLAN
- 99.PTH FOR SCREW HOLES
- 100.3rd USB

EC Modify History

Date                      EC version                      File name

---

smd.db-x7.ru

Security Classification	LC Future Center Secret Data			Title	
Issued Date	2012/05/01	Deciphered Date	2012/12/01	EC HISTORY	
<small>THIS SHEET OF ENGINEERING DRAWING IS THE PROPRIETARY PROPERTY OF LC FUTURE CENTER, AND CONTAINS CONFIDENTIAL AND TRADE SECRET INFORMATION. THIS SHEET MAY NOT BE TRANSFERRED FROM THE CUSTODY OF THE COMPETENT DIVISION OF R&amp;D DEPARTMENT EXCEPT AS AUTHORIZED BY LC FUTURE CENTER. NEITHER THIS SHEET NOR THE INFORMATION IT CONTAINS MAY BE USED BY OR DISCLOSED TO ANY THIRD PARTY WITHOUT PRIOR WRITTEN CONSENT OF LC FUTURE CENTER.</small>					Size C
				Document Number <b>COBRA IN UMA</b>	Rev 0.1
Date: Thursday, October 23, 2014					Sheet 2 of 100

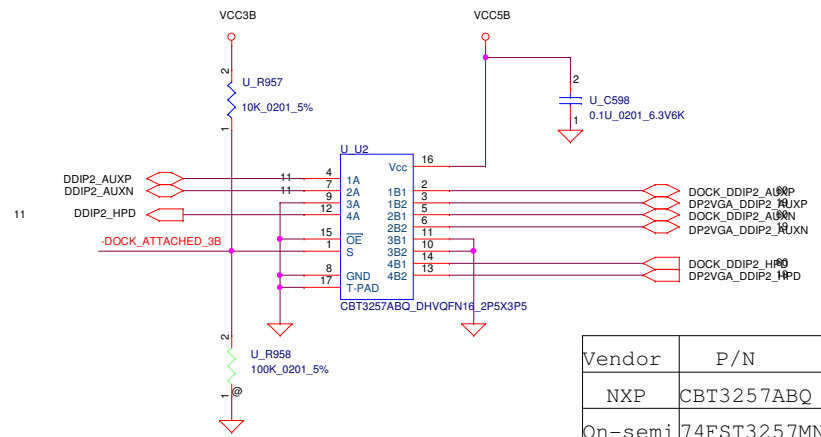
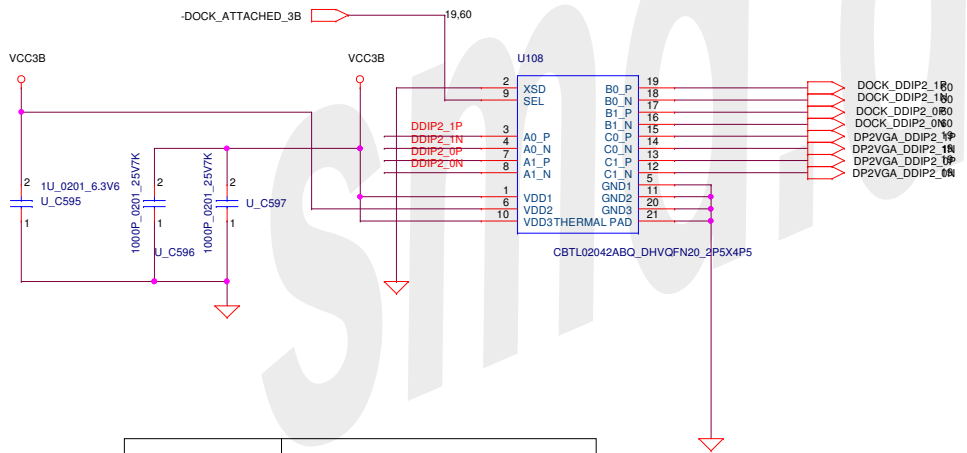
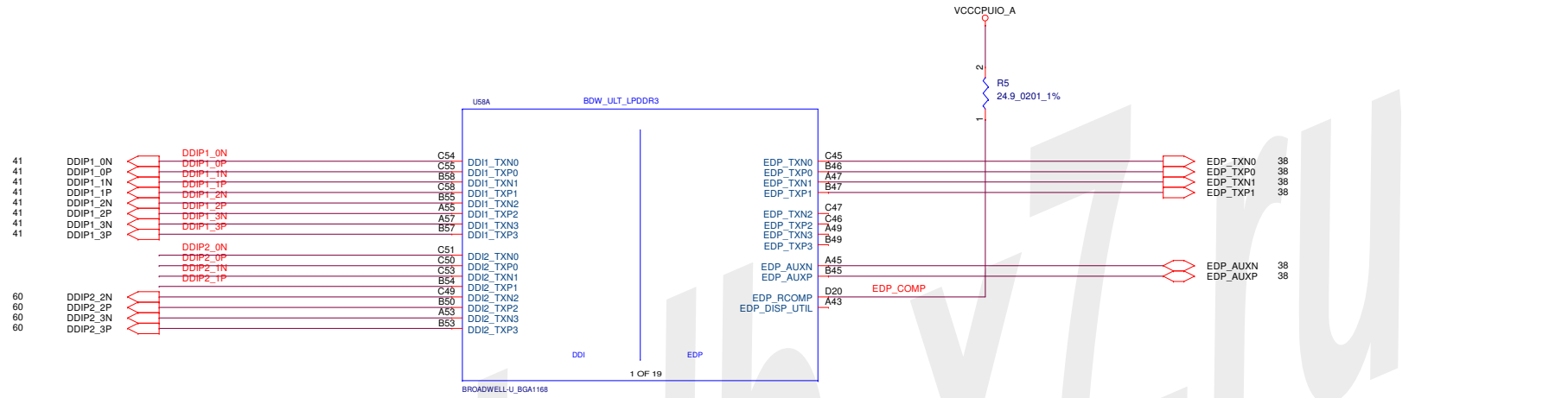

Vendor	P/N
Pericom	PI3PCIE3212
NXP	CBTL02042ABQ

Vendor	P/N
NXP	CBT3257ABQ
On-semi	74FST3257MNTWG

Security Classification				LC Future Center Secret Data				Title		
Issued Date	2012/05/01	Deciphered Date	2012/12/01	CPU(1/16) : DDI/EDP				Size	Document Number	
THIS SHEET OF ENGINEERING DRAWING IS THE PROPRIETARY PROPERTY OF LC FUTURE CENTER, AND CONTAINS CONFIDENTIAL AND TRADE SECRET INFORMATION. THIS SHEET MAY NOT BE TRANSFERRED FROM THE CUSTODY OF THE COMPETENT DIVISION OF R&D DEPARTMENT EXCEPT AS AUTHORIZED BY LC FUTURE CENTER NEITHER THIS SHEET NOR THE INFORMATION IT CONTAINS MAY BE USED BY OR DISCLOSED TO ANY THIRD PARTY WITHOUT PRIOR WRITTEN CONSENT OF LC FUTURE CENTER.				Date				Thursday, October 23, 2014	Sheet	3 of 100



COBAIN UMA

Rev 0.1

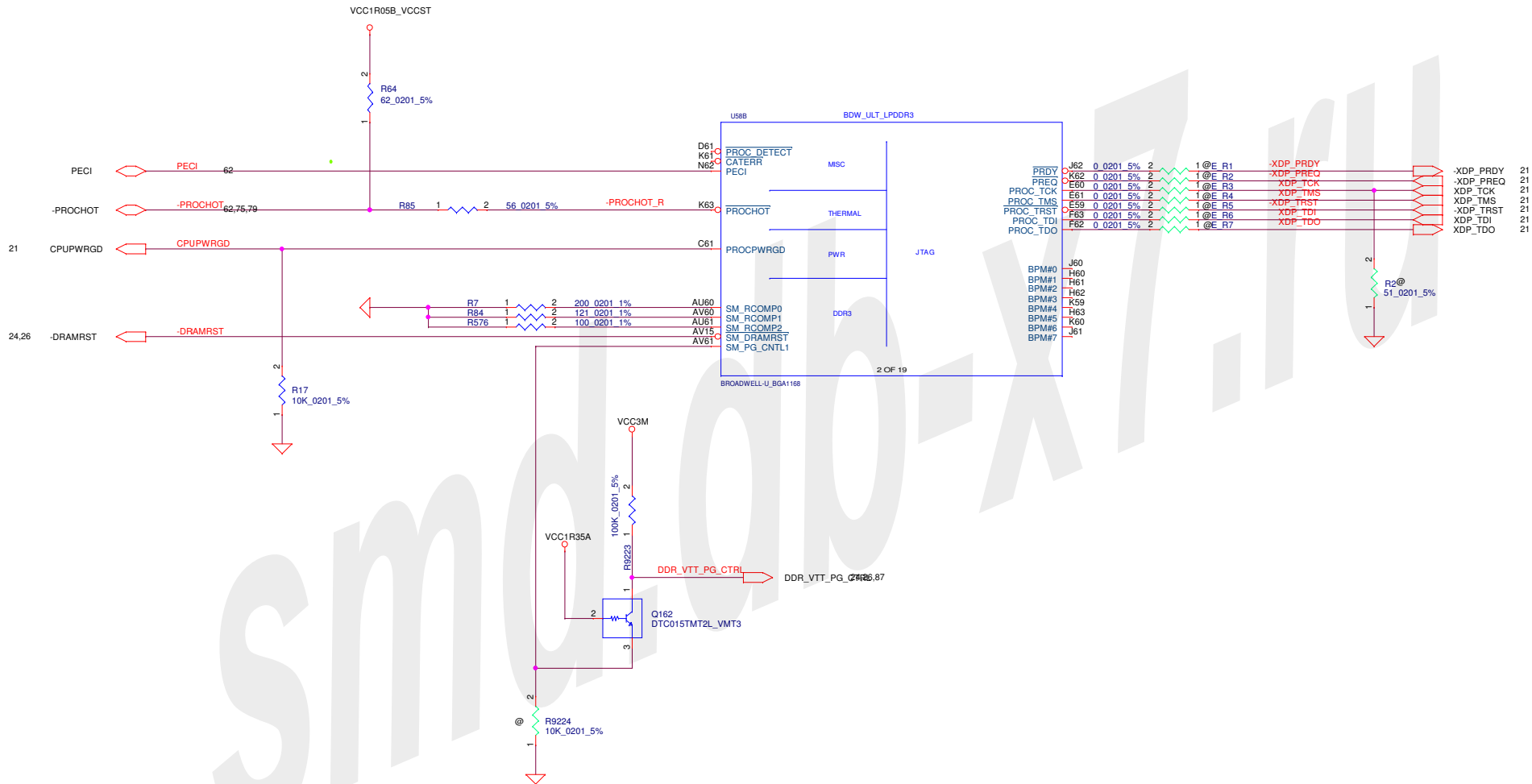

Security Classification	LC Future Center Secret Data	
Issued Date	2012/05/01	Deciphered Date
		2012/12/01

Title	
CPU(2/16) : MISC/JTAG	

THIS SHEET OF ENGINEERING DRAWING IS THE PROPRIETARY PROPERTY OF LC FUTURE CENTER, AND CONTAINS CONFIDENTIAL AND TRADE SECRET INFORMATION. THIS SHEET MAY NOT BE TRANSFERRED FROM THE CUSTODY OF THE COMPETENT DIVISION OF R&D DEPARTMENT EXCEPT AS AUTHORIZED BY LC FUTURE CENTER NEITHER THIS SHEET NOR THE INFORMATION IT CONTAINS MAY BE USED BY OR DISCLOSED TO ANY THIRD PARTY WITHOUT PRIOR WRITTEN CONSENT OF LC FUTURE CENTER.

Size	Document Number	Rev
Custom	COBAIN UMA	0.1

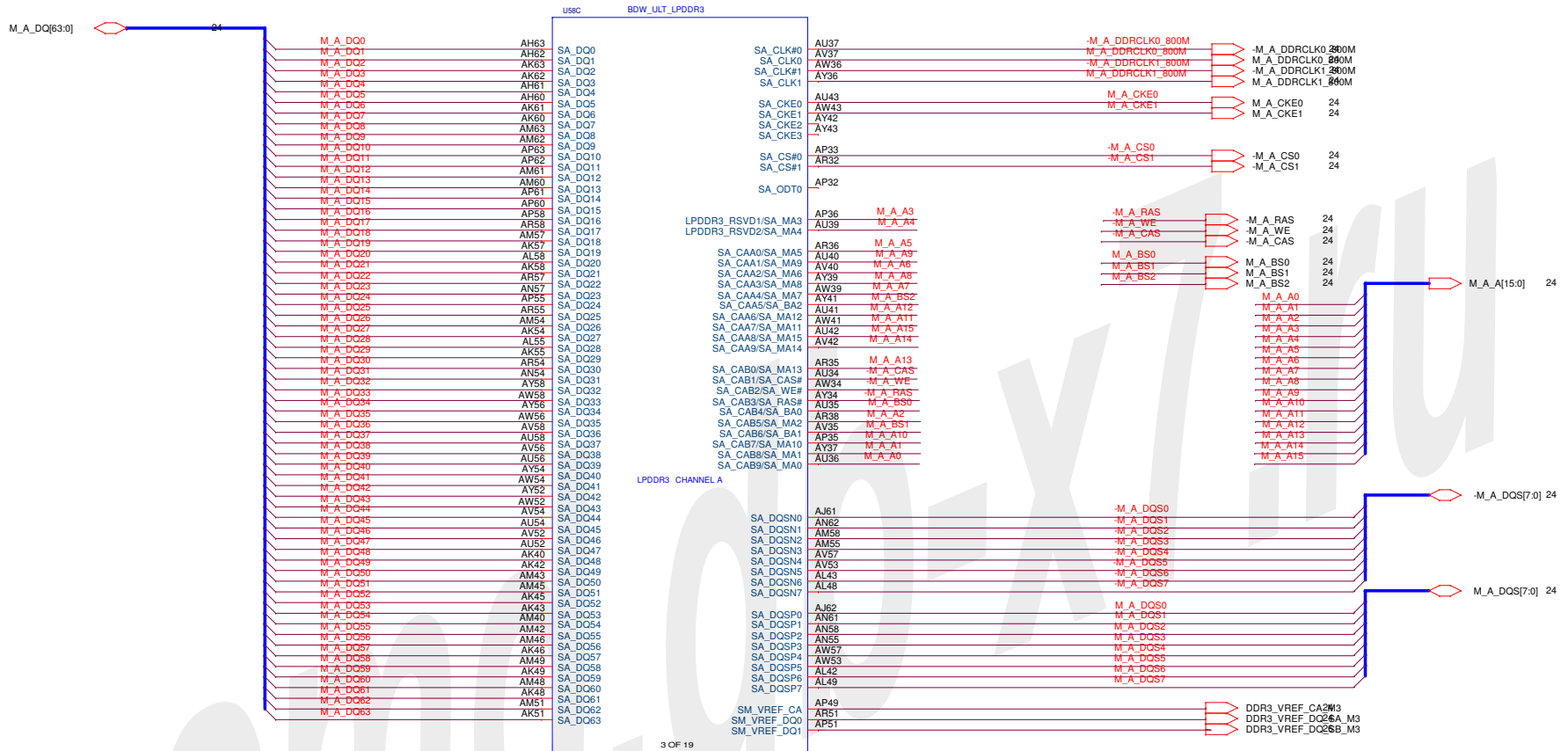

Security Classification		LC Future Center Secret Data		Title	
Issued Date	2012/05/01	Deciphered Date	2012/12/01	CPU(3/16) : DDR3L CHANNEL-A	
THIS SHEET OF ENGINEERING DRAWING IS THE PROPRIETARY PROPERTY OF LC FUTURE CENTER, AND CONTAINS CONFIDENTIAL AND TRADE SECRET INFORMATION. THIS SHEET MAY NOT BE TRANSFERRED FROM THE CUSTODY OF THE COMPETENT DIVISION OF R&D DEPARTMENT EXCEPT AS AUTHORIZED BY LC FUTURE CENTER NEITHER THIS SHEET NOR THE INFORMATION IT CONTAINS MAY BE USED BY OR DISCLOSED TO ANY THIRD PARTY WITHOUT PRIOR WRITTEN CONSENT OF LC FUTURE CENTER.				Size Custom	Document Number <b>COBAIN UMA</b>
Date:	Thursday, October 23, 2014	Sheet	5	of	100



Rev 0.1

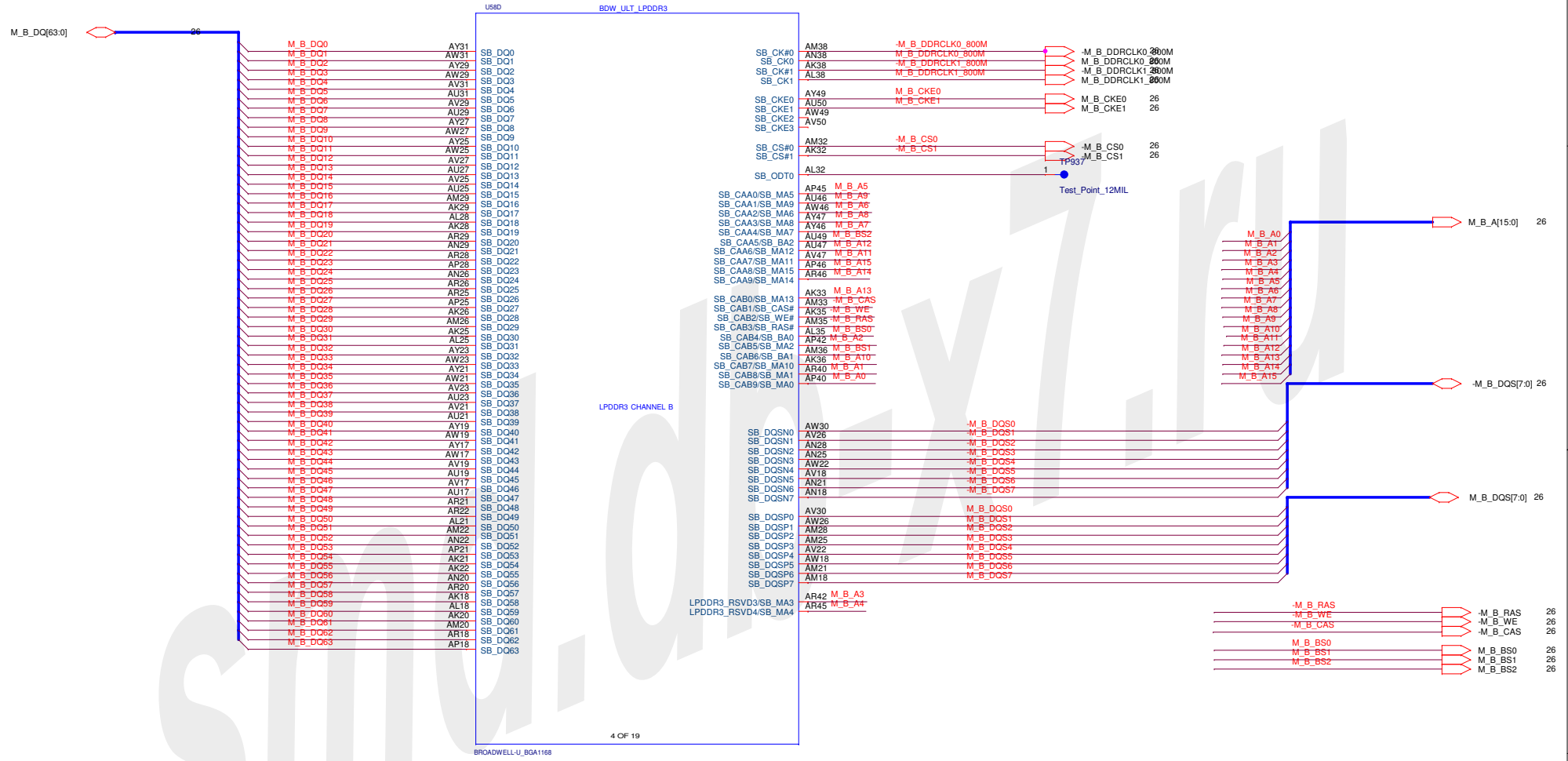

Security Classification	LC Future Center Secret Data		
Issued Date	2012/05/01	Deciphered Date	2012/12/01

Title	
CPU(4/16) : DDR3L CHANNEL-B	

THIS SHEET OF ENGINEERING DRAWING IS THE PROPRIETARY PROPERTY OF LC FUTURE CENTER, AND CONTAINS CONFIDENTIAL AND TRADE SECRET INFORMATION. THIS SHEET MAY NOT BE TRANSFERRED FROM THE CUSTODY OF THE COMPETENT DIVISION OF R&D DEPARTMENT EXCEPT AS AUTHORIZED BY LC FUTURE CENTER NEITHER THIS SHEET NOR THE INFORMATION IT CONTAINS MAY BE USED BY OR DISCLOSED TO ANY THIRD PARTY WITHOUT PRIOR WRITTEN CONSENT OF LC FUTURE CENTER.

Size	Document Number	Rev
Custom	COBAIN UMA	0.1
Date:	Thursday, October 23, 2014	Sheet 6 of 100



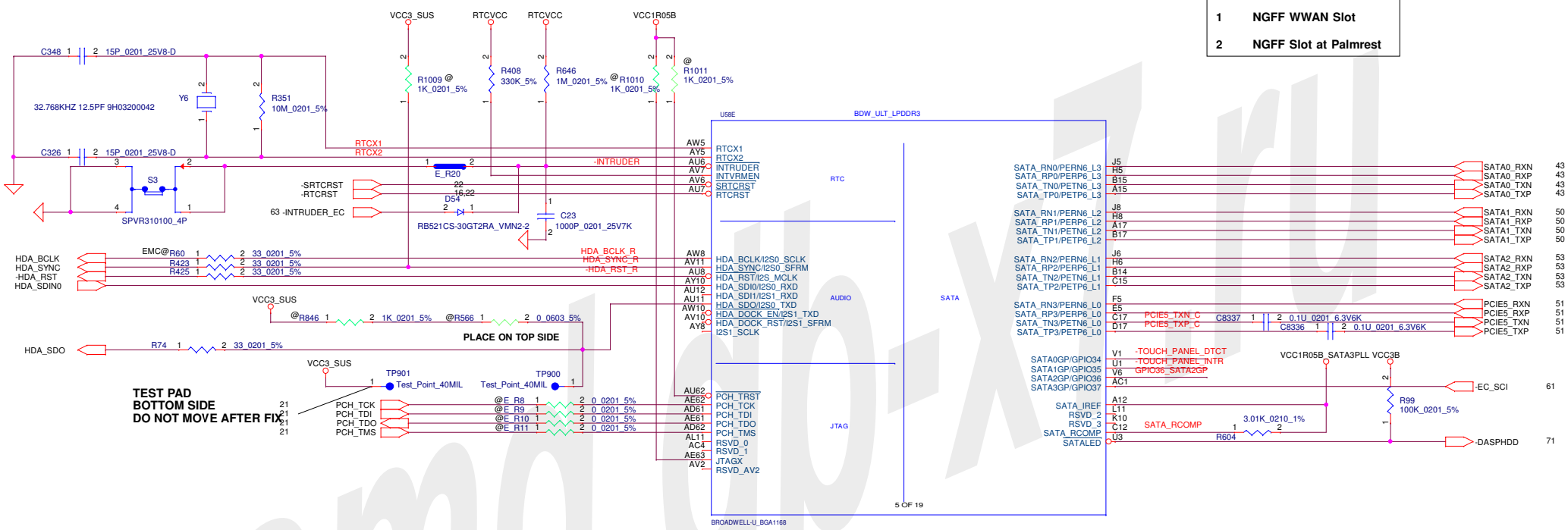

SATA Port Assignment	
0	HDD Connector
1	NGFF WWAN Slot
2	NGFF Slot at Palmrest

**TEST PAD  
BOTTOM SIDE  
DO NOT MOVE AFTER FIX**

- 21 PCH\_TCK @E R8 1 2 0 0201 5%
- 21 PCH\_TDI @E R9 1 2 0 0201 5%
- 21 PCH\_TDO @E R10 1 2 0 0201 5%
- 21 PCH\_TMS @E R11 1 2 0 0201 5%

**PLACE ON TOP SIDE**

- VCC3\_SUS @R846 1 2 1K 0201 5%
- VCC3\_SUS @R566 1 2 0 0603 5%

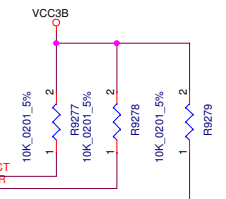

- TOUCH\_PANEL\_DTCT
- 3-TOUCH\_PANEL\_INTR
- TOUCH\_PANEL\_DTCT
- TOUCH\_PANEL\_INTR
- GPIO36\_SATA2GP

Security Classification	LC Future Center Secret Data		Title
Issued Date	2012/05/01	Deciphered Date	2012/12/01
THIS SHEET OF ENGINEERING DRAWING IS THE PROPRIETARY PROPERTY OF LC FUTURE CENTER, AND CONTAINS CONFIDENTIAL AND TRADE SECRET INFORMATION. THIS SHEET MAY NOT BE TRANSFERRED FROM THE CUSTODY OF THE COMPETENT DIVISION OF R&D DEPARTMENT EXCEPT AS AUTHORIZED BY LC FUTURE CENTER NEITHER THIS SHEET NOR THE INFORMATION IT CONTAINS MAY BE USED OR DISCLOSED TO ANY THIRD PARTY WITHOUT PRIOR WRITTEN CONSENT OF LC FUTURE CENTER.			Size   Document Number Custom   <b>COBAIN UMA</b> Date: Thursday, October 23, 2014   Sheet 7 of 100

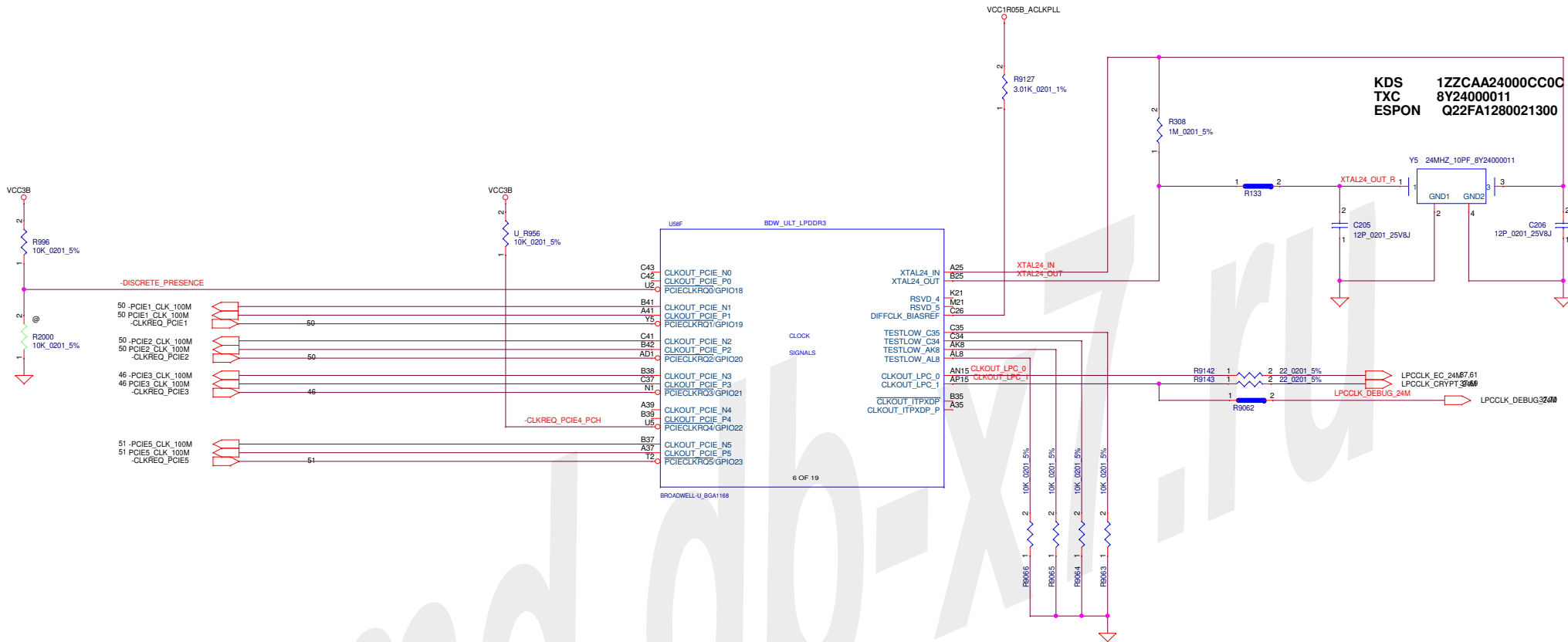

KDS 1ZZCAA24000CC0C  
 TXC 8Y24000011  
 ESPON Q22FA1280021300

Security Classification	LC Future Center Secret Data		Title	
Issued Date	2012/05/01	Deciphered Date	2012/12/01	
THIS SHEET OF ENGINEERING DRAWING IS THE PROPRIETARY PROPERTY OF LC FUTURE CENTER, AND CONTAINS CONFIDENTIAL AND TRADE SECRET INFORMATION. THIS SHEET MAY NOT BE TRANSFERRED FROM THE CUSTODY OF THE COMPETENT DIVISION OF R&D DEPARTMENT EXCEPT AS AUTHORIZED BY LC FUTURE CENTER. NEITHER THIS SHEET NOR THE INFORMATION IT CONTAINS MAY BE USED BY OR DISCLOSED TO ANY THIRD PARTY WITHOUT PRIOR WRITTEN CONSENT OF LC FUTURE CENTER.				Size Custom
CPU(6/16) : CLOCK SIGNALS			Document Number <b>COBAIN UMA</b>	Rev 0.1
Date: Thursday, October 23, 2014			Sheet 8 of 100	

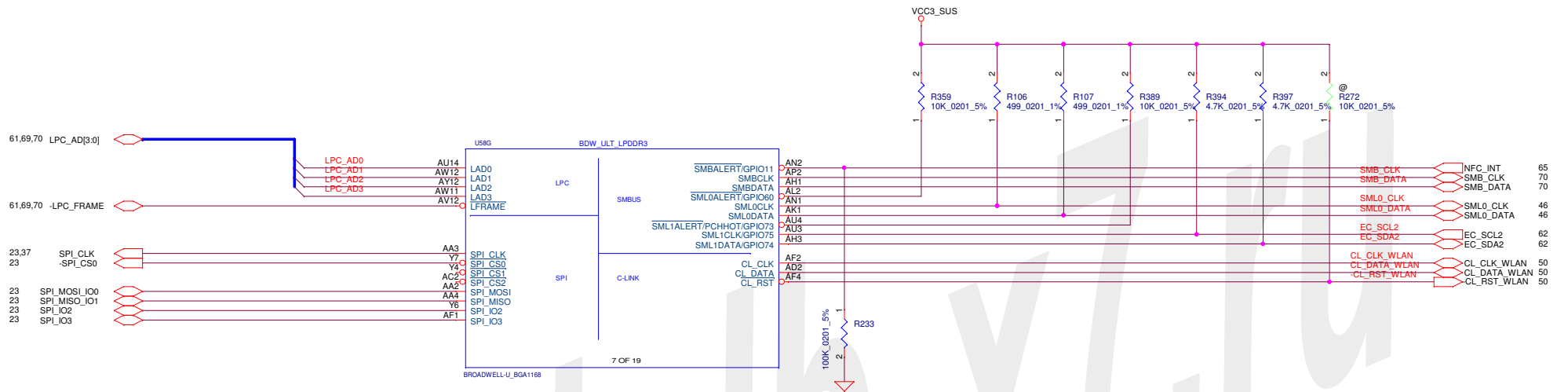

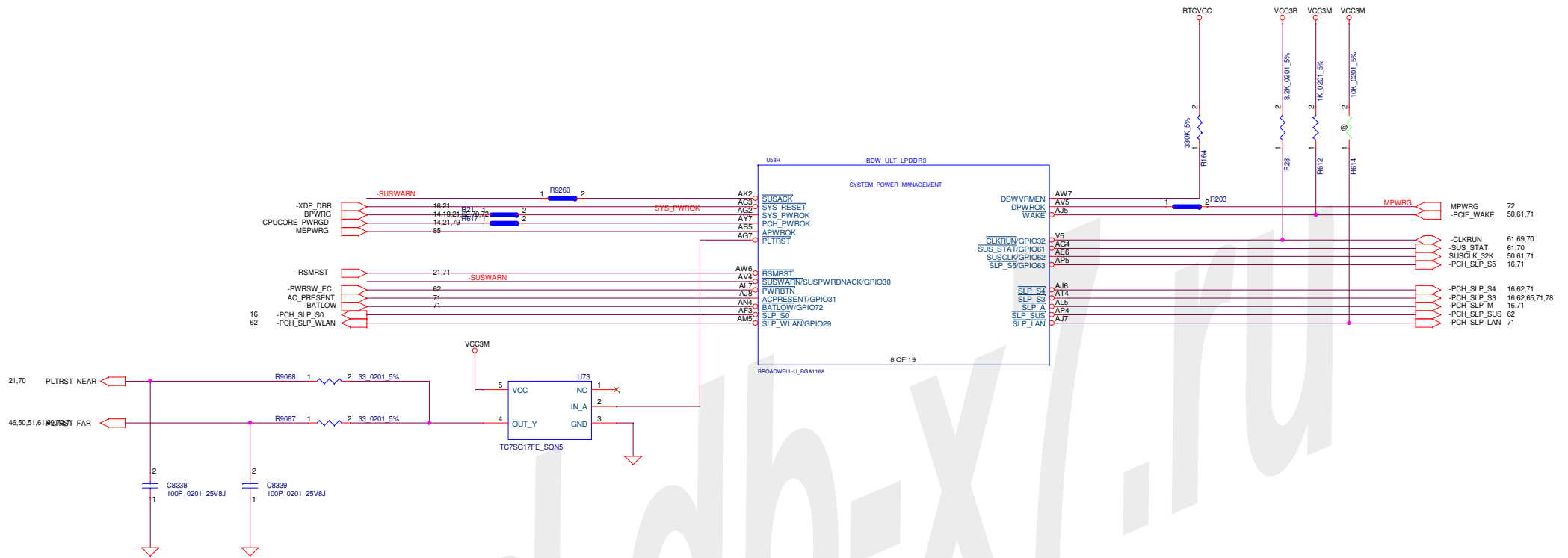

smd.dbo-x7711d

Security Classification		LC Future Center Secret Data		Title		
Issued Date	2012/05/01	Deciphered Date	2012/12/01	CPU(7/16) : LPC/SPI/SMBUS/C-LINK		
THIS SHEET OF ENGINEERING DRAWING IS THE PROPRIETARY PROPERTY OF LC FUTURE CENTER, AND CONTAINS CONFIDENTIAL AND TRADE SECRET INFORMATION. THIS SHEET MAY NOT BE TRANSFERRED FROM THE CUSTODY OF THE COMPETENT DIVISION OF R&D DEPARTMENT EXCEPT AS AUTHORIZED BY LC FUTURE CENTER NEITHER THIS SHEET NOR THE INFORMATION IT CONTAINS MAY BE USED BY OR DISCLOSED TO ANY THIRD PARTY WITHOUT PRIOR WRITTEN CONSENT OF LC FUTURE CENTER.				Size	Document Number	Rev
				Custom	<b>COBAIN UMA</b>	0.1
				Date:	Thursday, October 23, 2014	Sheet 9 of 100



**TABLE**

- CFG2 : PEG Static Lane Reversal**  
 1 : Normal Operation  
 0 : Lane Reversal
- CFG4 : Display Port Presence**  
 1 : Disabled  
 0 : Enabled
- CFG[6:5] : PEG Bifurcation**  
 11 : Func 1 Disabled, Func 2 Disabled (x16,---,---)  
 10 : Func 1 Enabled, Func 2 Disabled (x8,x8,---)  
 01 : Func 1 Disabled, Func 2 Enabled  
 00 : Func 1 Enabled, Func 2 Enabled (x8,x4,x4)
- CFG7 : PEG Defer Training**  
 1 : PEG Train Immediately Following XXRESETB Deassertion  
 0 : PEG Wait for BIOS for Training

Security Classification	LC Future Center Secret Data		Title	 <b>CPU(8/16) : SYSTEM PM</b>
Issued Date	2012/05/01	Deciphered Date	2012/12/01	
<small>THIS SHEET OF ENGINEERING DRAWING IS THE PROPRIETARY PROPERTY OF LC FUTURE CENTER, AND CONTAINS CONFIDENTIAL AND TRADE SECRET INFORMATION. THIS SHEET MAY NOT BE TRANSFERRED FROM THE CUSTODY OF THE COMPETENT DIVISION OF R&amp;D DEPARTMENT EXCEPT AS AUTHORIZED BY LC FUTURE CENTER. NEITHER THIS SHEET NOR THE INFORMATION IT CONTAINS MAY BE USED BY OR DISCLOSED TO ANY THIRD PARTY WITHOUT PRIOR WRITTEN CONSENT OF LC FUTURE CENTER.</small>				Size Custom
Date: Thursday, October 23, 2014				Rev 0.1
Sheet 10 of 100				

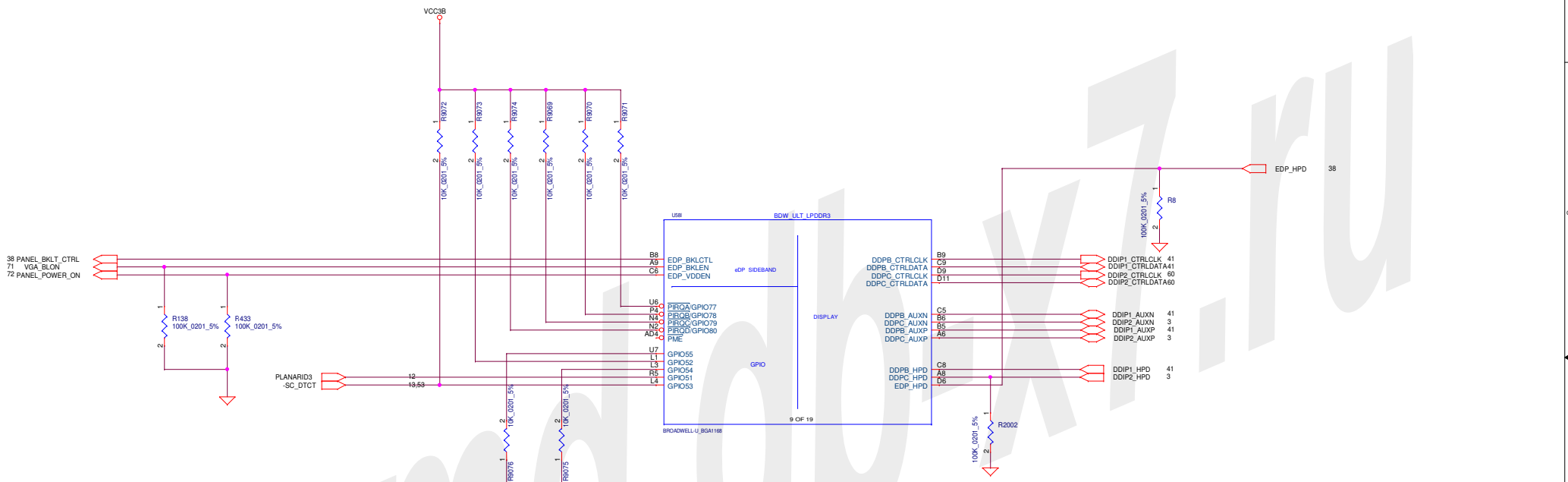

Security Classification	LC Future Center Secret Data		Title
Issued Date	2012/05/02	Deciphered Date	2012/5/02
THIS SHEET OF ENGINEERING DRAWING IS THE PROPRIETARY PROPERTY OF LC FUTURE CENTER, AND CONTAINS CONFIDENTIAL AND TRADE SECRET INFORMATION. THIS SHEET MAY NOT BE TRANSFERRED FROM THE CUSTODY OF THE COMPETENT DIVISION OF R&D DEPARTMENT EXCEPT AS AUTHORIZED BY LC FUTURE CENTER. NEITHER THIS SHEET NOR THE INFORMATION IT CONTAINS MAY BE USED BY OR DISCLOSED TO ANY THIRD PARTY WITHOUT PRIOR WRITTEN CONSENT OF LC FUTURE CENTER.			
Size	Document Number		Rev
C			0.1
Date:	Thursday, October 23, 2014	Sheet	11 of 100

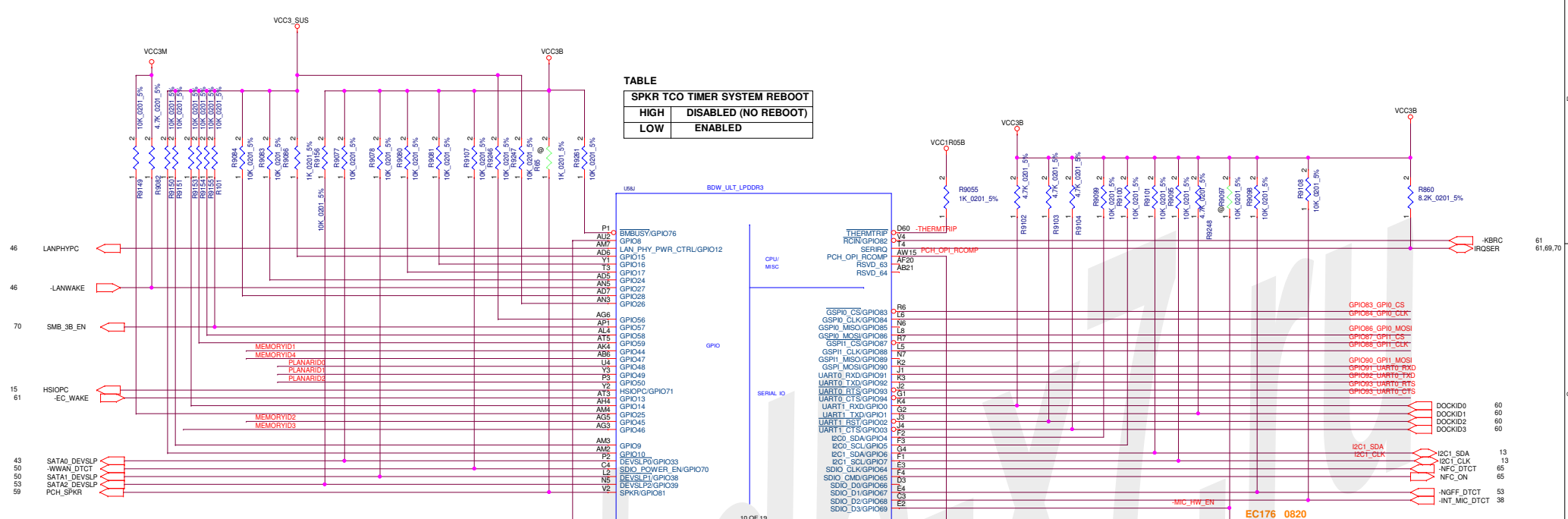

**TABLE**

**SPKR TCO TIMER SYSTEM REBOOT**

HIGH	DISABLED (NO REBOOT)
LOW	ENABLED

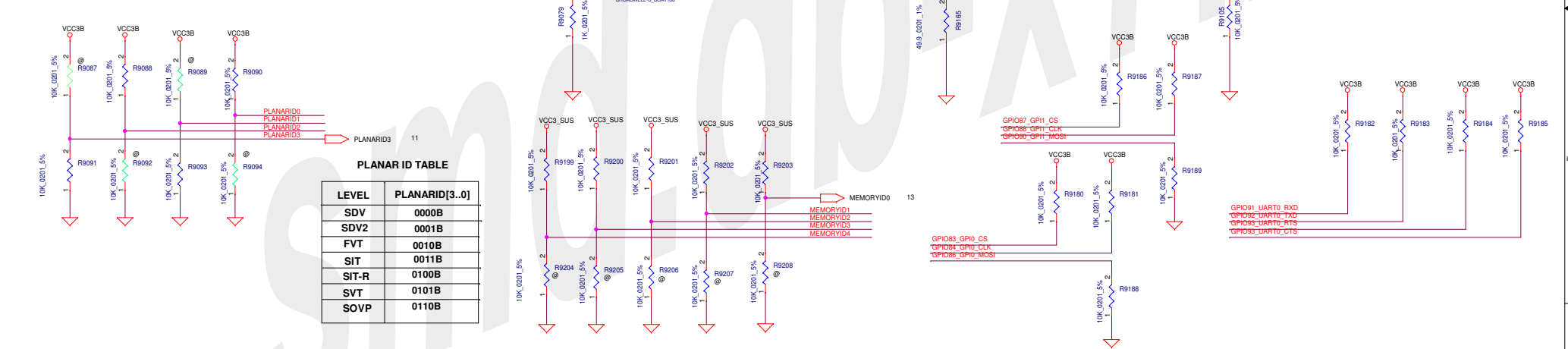

**PLANAR ID TABLE**

LEVEL	PLANARID[3..0]
SDV	0000B
SDV2	0001B
FVT	0010B
SIT	0011B
SIT-R	0100B
SVT	0101B
SOVP	0110B

MemoryID0	MemoryID1	MemoryID2	MemoryID3	MemoryID4	Supplier	Density	P/N	BOM Structure
GPIO43#	GPIO44	GPIO45	GPIO46	GPIO47				
1	0	0	0	0	Samsung	8Gb	K4B8G1646Q-MYK0	S4G@
1	1	0	0	0	Micron	8Gb	MT41K512M16TNA-125-E	M4G@
1	1	1	0	0	Elpida	8Gb	EDJ8416E6MB-GN-F	E4G@
1	1	1	1	0	SK Hynix	8Gb	H5TC8G63AMR-PBA	H4G@
1	1	1	1	1	no on-board memory model	N/A	N/A	NA@

Security Classification	LC Future Center Secret Data		Title	<b>CPU(10/16) : GPIO/CPU/MISC/LPIO</b>
Issued Date	2012/05/02	Deciphered Date	2012/05/02	
<small>THIS SHEET OF ENGINEERING DRAWING IS THE PROPRIETARY PROPERTY OF LC FUTURE CENTER, AND CONTAINS CONFIDENTIAL AND TRADE SECRET INFORMATION. THIS SHEET MAY NOT BE TRANSFERRED FROM THE CUSTODY OF THE COMPETENT DIVISION OF R&amp;D DEPARTMENT EXCEPT AS AUTHORIZED BY LC FUTURE CENTER. NEITHER THIS SHEET NOR THE INFORMATION IT CONTAINS MAY BE USED BY OR DISCLOSED TO ANY THIRD PARTY WITHOUT PRIOR WRITTEN CONSENT OF LC FUTURE CENTER.</small>				
Size C	Document Number	Sheet	12 of 100	Rev 0.1
Date:	Thursday, October 23, 2014	Sheet	12 of 100	

Flexible I/O Configuration			
I/O	High Speed Signals	Configuration	Net Name
Port 1	USB3 1	USB3 1	USB3P0
Port 2	USB3 2	USB3 2	USB3P1
Port 3	PCIE 1/USB3 3	USB3 3	USB3P2
Port 4	PCIE 2/USB3 4	PCIE 2	PCIE1
Port 5	PCIE 3	PCIE 3	PCIE2
Port 6	PCIE 4	PCIE 4	PCIE3
Port 7	PCIE 5 L0	PCIE 5 L0	PCIE4_0
Port 8	PCIE 5 L1	PCIE 5 L1	PCIE4_1
Port 9	PCIE 5 L2	PCIE 5 L2	PCIE4_2
Port 10	PCIE 5 L3	PCIE 5 L3	PCIE4_3
Port 11	PCIE 6 L0	PCIE 6 L0	PCIE5
Port 12	SATA 2/PCIE 6 L1	SATA 2	SATA2
Port 13	SATA 1/PCIE 6 L2	SATA 1	SATA1
Port 14	SATA 0/PCIE 6 L3	SATA 0	SATA0

PCIe Port Assignment	
1	NGFF WLAN Slot Port1
2	NGFF WLAN Slot Port2
3	GbE PHY
4 (x4)	Reserve
5 (x1)	Media Card Controller

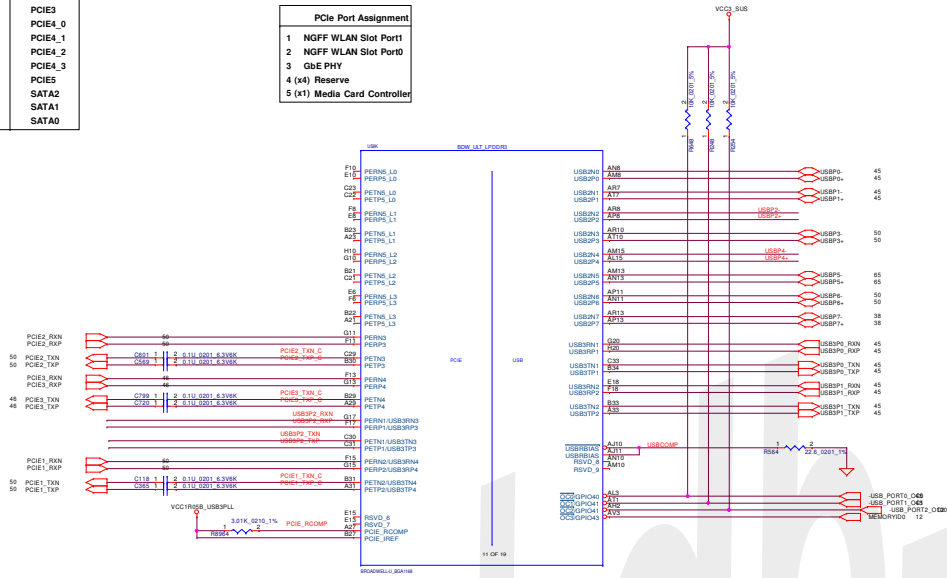

USB Port Assignment	
0	USB 3.0 System Port (AOU)
1	USB 3.0 System Port (Debug)
2	USB 3.0 Docking/3rd USB3.0 System Port
3	NGFF WWAN Slot
4	Smart Card Slot / Touch Panel
5	Fingerprint Reader
6	NGFF WLAN Slot
7	USB Camera

USB 3.0 Port Assignment	
0	USB 3.0 System Port (AOU)
1	USB 3.0 System Port (Debug)
2	USB 3.0 Docking

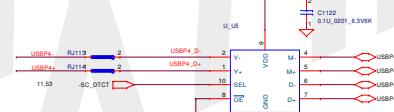
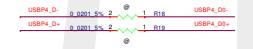

Device Selection	
0	Smart Card Slot
1	Touch Panel

CIS SYMBOL ONLY



CIS SYMBOL ONLY

Vendor	P/N
Pericom	PI3USB102ZME
NXP	NX3DV42GU

PN Apply

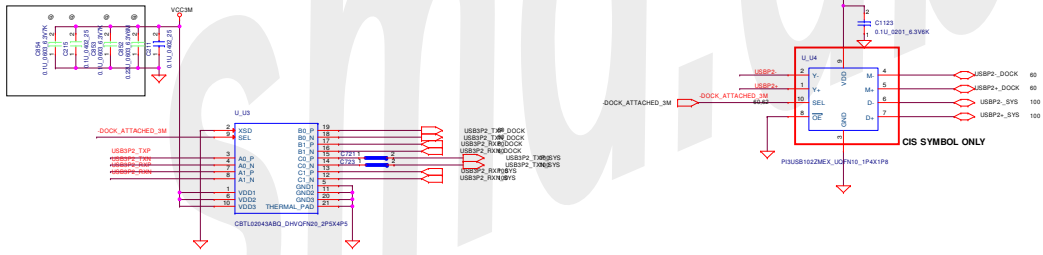

Vendor	P/N
Pericom	PI3PCIE3212
NXP	CBTL02043ABQ

Security Classification	LC Future Center Secret Data	Title		
Issued Date	2012/05/02	Discontinued Date	2012/05/02	CPM(11/10) - PCIE/USB
THIS SHEET OF ENGINEERING DRAWING IS THE PROPRIETARY PROPERTY OF LG FUTURE CENTER AND CONTAINS CONFIDENTIAL AND TRADE SECRET INFORMATION. THIS SHEET SHALL NOT BE REPRODUCED, COPIED, OR TRANSMITTED IN ANY FORM OR BY ANY MEANS WITHOUT THE WRITTEN PERMISSION OF LG FUTURE CENTER.				
Rev	0	Document Number	REV 01	
File	WORKING_DRAWING_PCB		Page	13 of 100



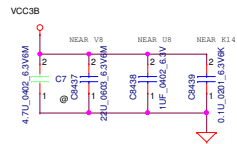
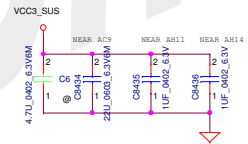
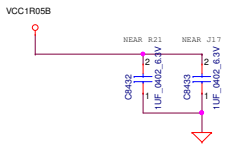
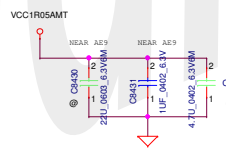
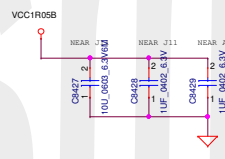
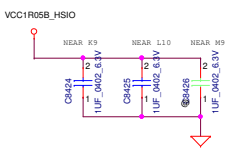
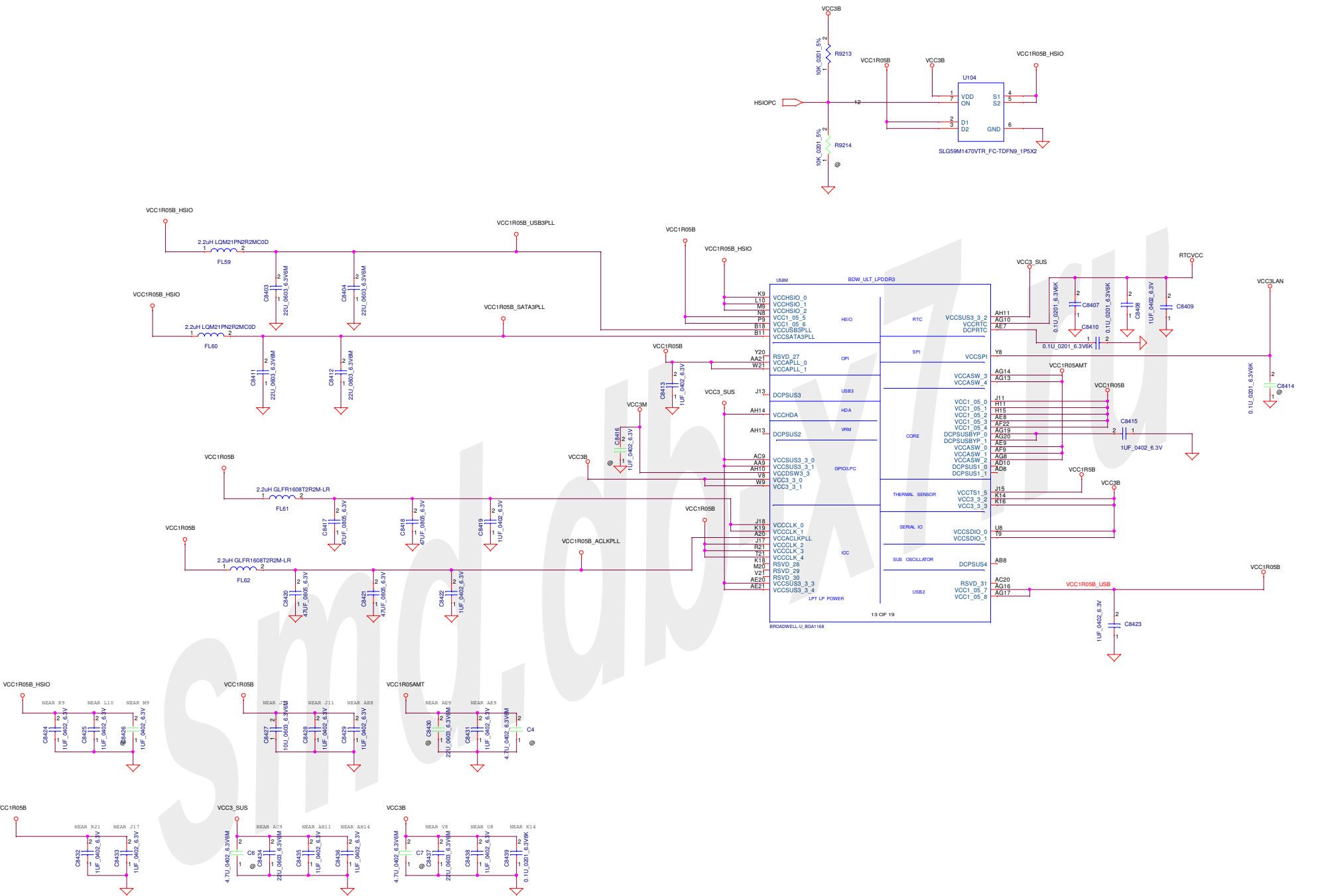

Security Classification	LC Future Center Secret Data		Title	
Issued Date	2012/05/02	Deciphered Date	2012/5/02	
THIS SHEET OF ENGINEERING DRAWING IS THE PROPRIETARY PROPERTY OF LC FUTURE CENTER, AND CONTAINS CONFIDENTIAL AND TRADE SECRET INFORMATION. THIS SHEET MAY NOT BE TRANSFERRED FROM THE CUSTODY OF THE COMPETENT DIVISION OF R&D DEPARTMENT EXCEPT AS AUTHORIZED BY LC FUTURE CENTER. NEITHER THIS SHEET NOR THE INFORMATION IT CONTAINS MAY BE USED BY OR DISCLOSED TO ANY THIRD PARTY WITHOUT PRIOR WRITTEN CONSENT OF LC FUTURE CENTER.				Size: Document Number Date: Thursday, October 23, 2014 Sheet 15 of 100



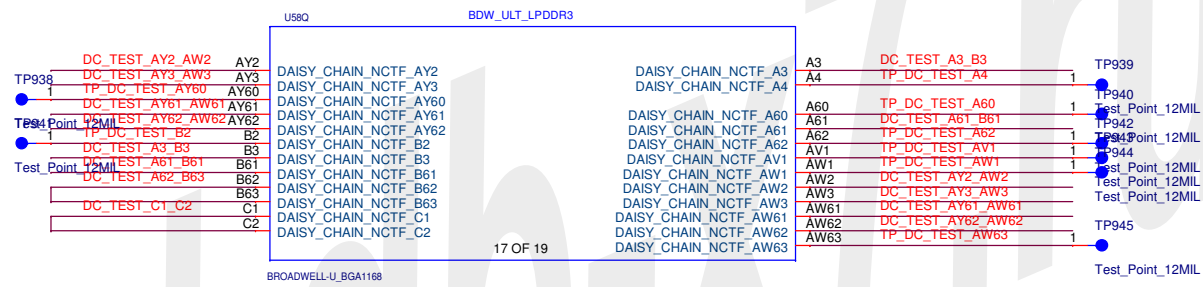

17 OF 19

BROADWELL-U\_BGA1168

Security Classification		LC Future Center Secret Data		Title	
Issued Date	2012/05/02	Deciphered Date	2012/5/02	CPU(15/16) : NCTF	
THIS SHEET OF ENGINEERING DRAWING IS THE PROPRIETARY PROPERTY OF LC FUTURE CENTER, AND CONTAINS CONFIDENTIAL AND TRADE SECRET INFORMATION. THIS SHEET MAY NOT BE TRANSFERRED FROM THE CUSTODY OF THE COMPETENT DIVISION OF R&D DEPARTMENT EXCEPT AS AUTHORIZED BY LC FUTURE CENTER NEITHER THIS SHEET NOR THE INFORMATION IT CONTAINS MAY BE USED BY OR DISCLOSED TO ANY THIRD PARTY WITHOUT PRIOR WRITTEN CONSENT OF LC FUTURE CENTER.				Size	Rev
				Document Number	0.1
Date:	Thursday, October 23, 2014	Sheet	17	of	100



KDS  
TXC  
ESPN

1ZZHAE2700CC0A  
8Y27000005  
Q22FA128007000

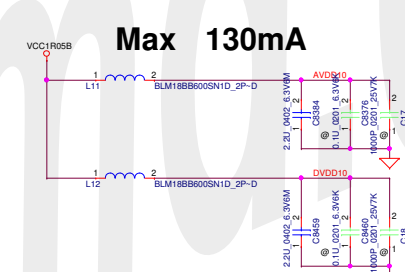
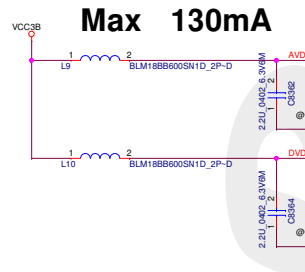
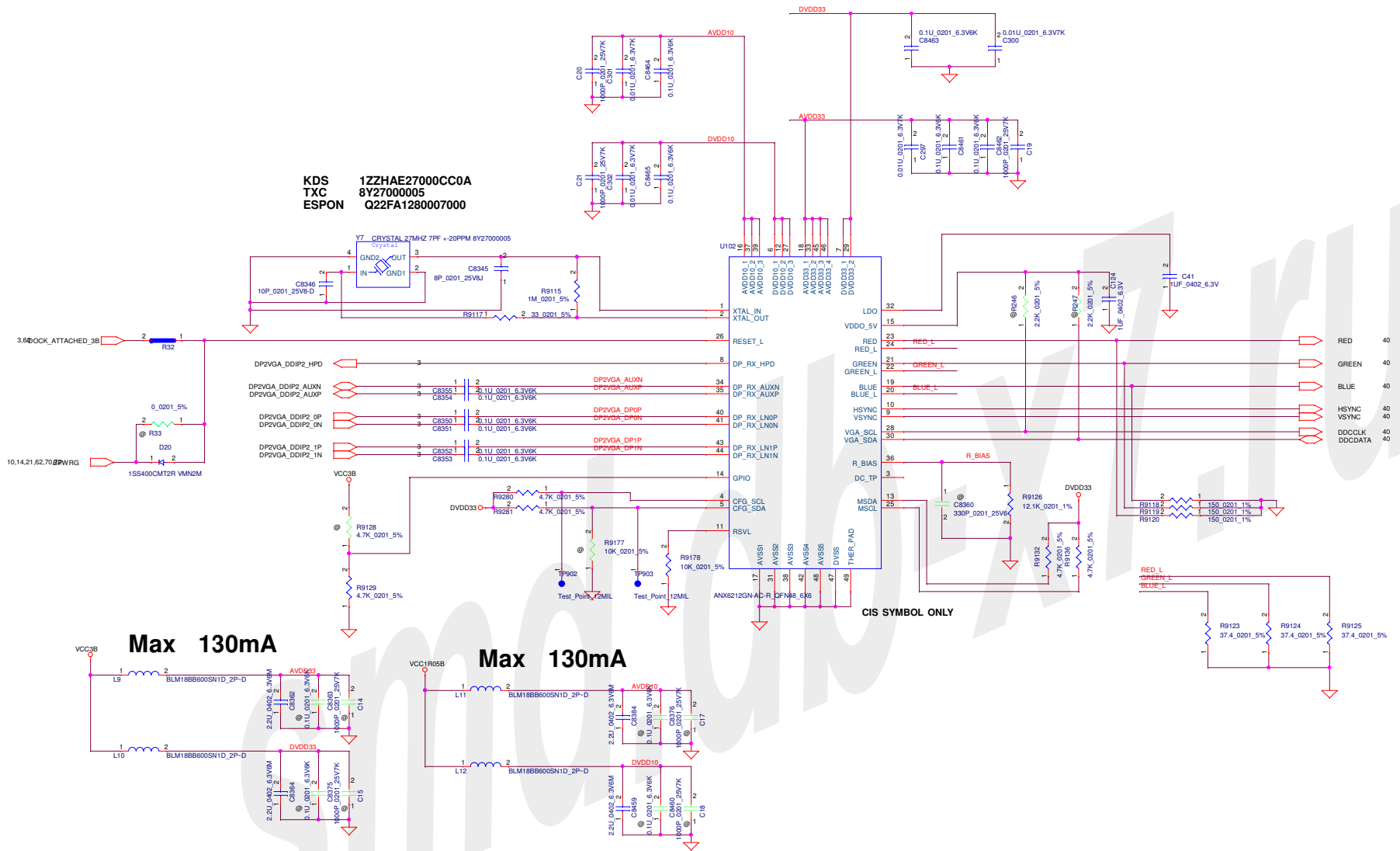

2.2uF, 0.1uF, 1000pF: Near filter

Security Classification	LC Future Center Secret Data		Title	DDI-VGA CONVERTER COBAIN LIMA	
Issued Date	2012/06/21	Deciphered Date	2012/06/21		
THIS SHEET OF ENGINEERING DRAWING IS THE PROPRIETARY PROPERTY OF LC FUTURE CENTER, AND CONTAINS CONFIDENTIAL AND TRADE SECRET INFORMATION. THIS SHEET MAY NOT BE TRANSFERRED FROM THE CUSTODY OF THE COMPETENT DIVISION OF R&D DEPARTMENT EXCEPT AS AUTHORIZED BY LC FUTURE CENTER. NEITHER THIS SHEET NOR THE INFORMATION IT CONTAINS MAY BE USED BY OR DISCLOSED TO ANY THIRD PARTY WITHOUT PRIOR WRITTEN CONSENT OF LC FUTURE CENTER.					Rev 0.1
Date:				Thursday, October 23, 2014	Sheet 19 of 100

BLANK

smd.dib-x7.ru

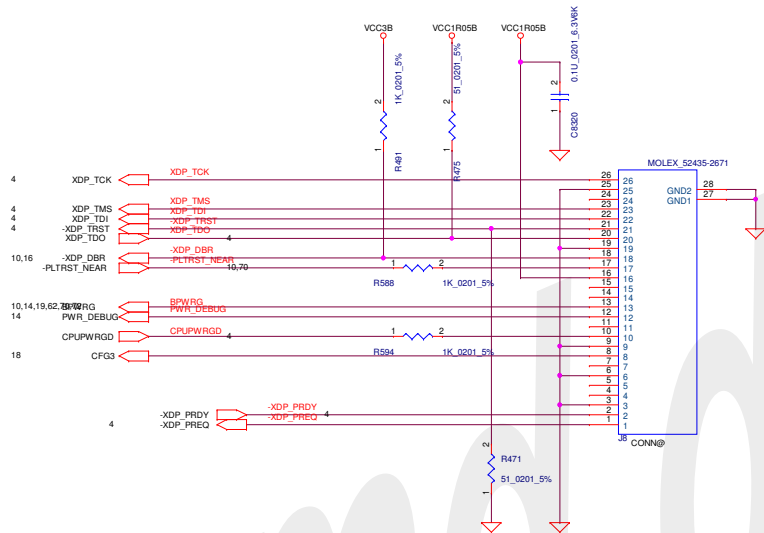

TABLE CPU ITP DEBUG PORT

SIGNAL	REF DES	PLANER ONLY	DISABLE
TDO	R475	ASM	ASM
TRST#	R471	ASM	ASM
DBRST#	R491	ASM	ASM
RESET#	R588	ASM	ASM
PWRGD	R594	ASM	ASM
CONNETER	J6	ASM	NO ASM

NOTE:APPLY EACH ACCORDING TO CONFIGURATION IN SDV

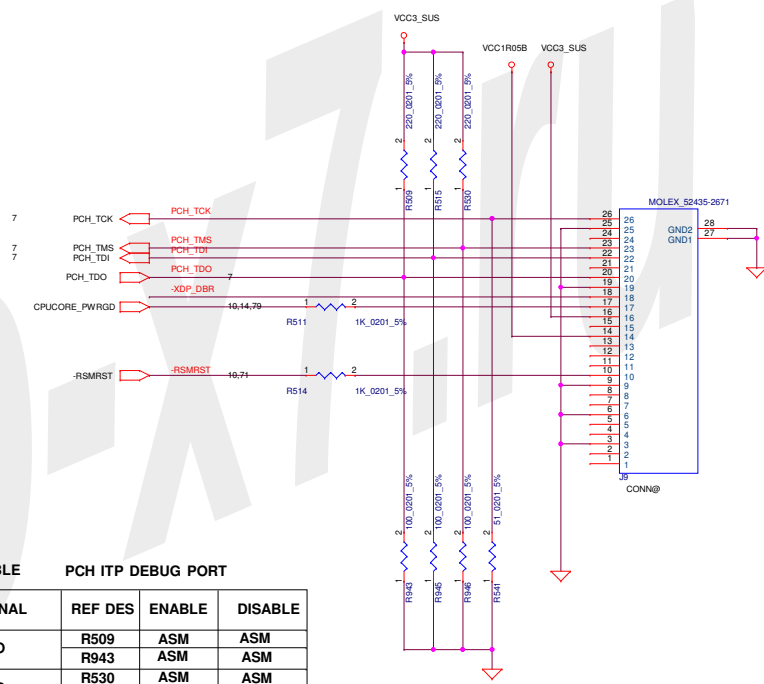
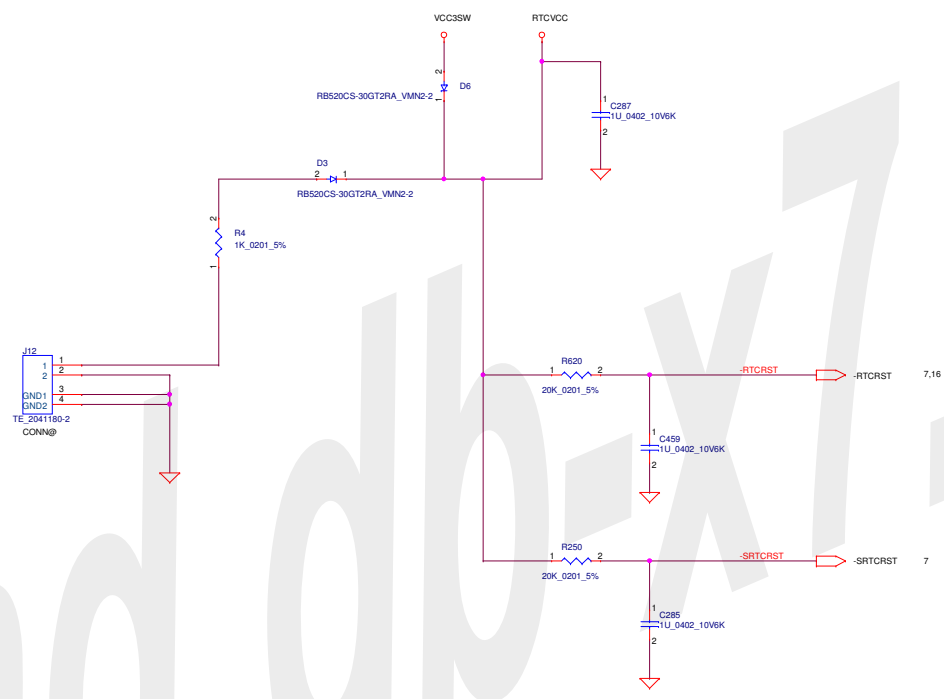

TABLE PCH ITP DEBUG PORT

SIGNAL	REF DES	ENABLE	DISABLE
TDO	R509	ASM	ASM
	R943	ASM	ASM
TMS	R530	ASM	ASM
	R946	ASM	ASM
TDI	R515	ASM	ASM
	R945	ASM	ASM
TCK	R541	ASM	ASM
CPUCORE_PWRGD	R511	ASM	ASM
-RSMRST	R514	ASM	ASM
CONNETER	J9	ASM	NO ASM

NOTE:APPLY EACH ACCORDING TO CONFIGURATION IN SDV



smd.dib-x7.ru

Security Classification	LC Future Center Secret Data		Title
Issued Date	2012/07/01	Deciphered Date	2014/07/01
THIS SHEET OF ENGINEERING DRAWING IS THE PROPRIETARY PROPERTY OF LC FUTURE CENTER, AND CONTAINS CONFIDENTIAL AND TRADE SECRET INFORMATION. THIS SHEET MAY NOT BE TRANSFERRED FROM THE CUSTODY OF THE COMPETENT DIVISION OF R&D DEPARTMENT EXCEPT AS AUTHORIZED BY LC FUTURE CENTER. NEITHER THIS SHEET NOR THE INFORMATION IT CONTAINS MAY BE USED BY OR DISCLOSED TO ANY THIRD PARTY WITHOUT PRIOR WRITTEN CONSENT OF LC FUTURE CENTER.			<b>RTC BATTERY</b> Size:   Document Number:   Rev:   Chain:     01 Date: Thursday, October 23, 2014   Sheet 22 of 100



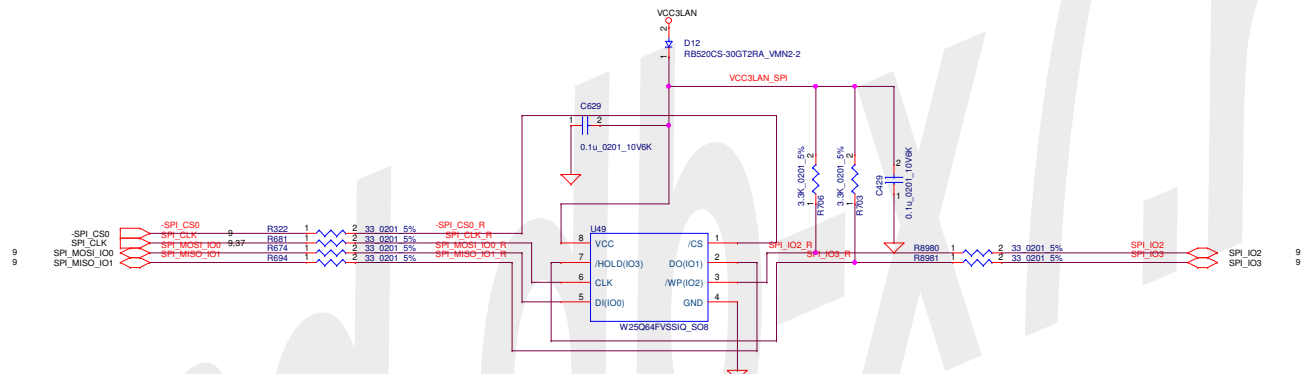

TABLE

SF100 PIN HEADER INTERFACE (TOP VIEW)					
1	VCC	D12.1	GND	GND	2
3	CS#	R322.2	R881.2	CLK	4
5	MISO	R694.2	R674.2	MOSI	6
7	(KEY)	N/A	N/A	(RESET)	8

U49 SPI ROM

vPro / non-vPro Model (16MB)	
WINBOND	W25Q128FYSIQ
MACRONIX	MX25L1287FM2-10G
MICRON	N25Q128A13ESEC00F

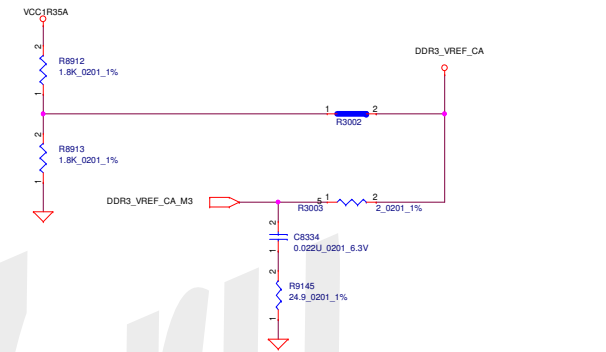
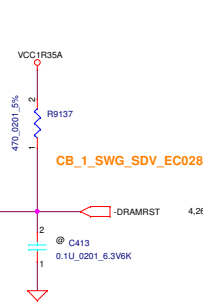
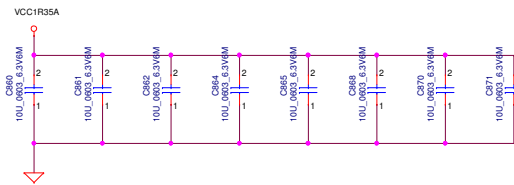
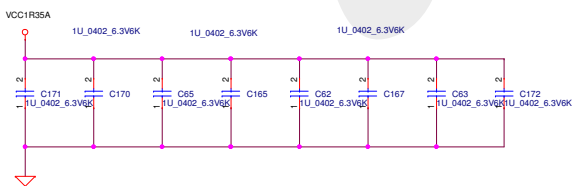
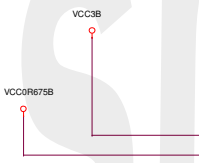
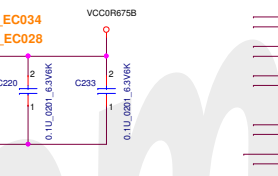
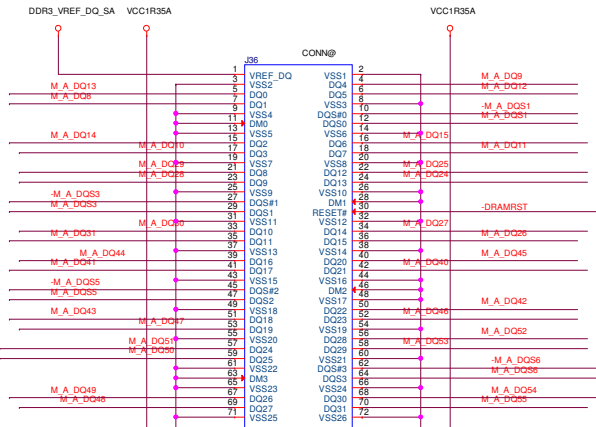
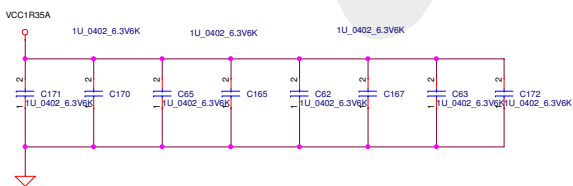
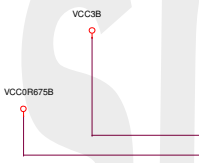
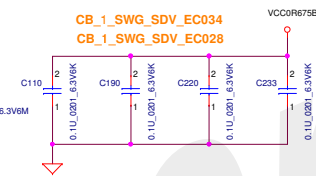
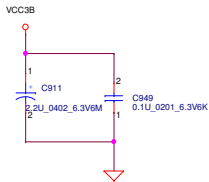
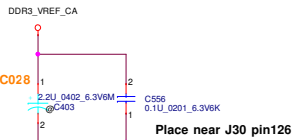
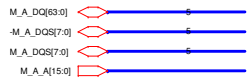

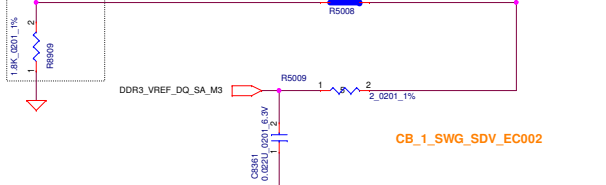
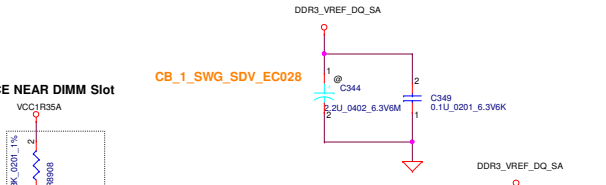
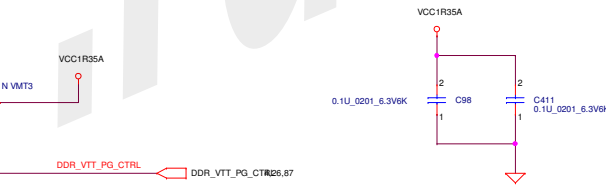

PLACE 1UF NEAR VCC1R35A PIN.



Security Classification	LC Future Center Secret Data		THIS SHEET IS FOR	DDR3L BASE MEMORY CH-A (1/2)
Issued Date	2012/06/21	Deciphered Date	2012/06/21	
THIS SHEET OF ENGINEERING DRAWING IS THE PROPRIETARY PROPERTY OF LC FUTURE CENTER, AND CONTAINS CONFIDENTIAL AND TRADE SECRET INFORMATION. THIS SHEET MAY NOT BE TRANSFERRED FROM THE CUSTODY OF THE COMPETENT DIVISION OF R&D DEPARTMENT EXCEPT AS AUTHORIZED BY LC FUTURE CENTER. NEITHER THIS SHEET NOR THE INFORMATION IT CONTAINS MAY BE USED BY OR DISCLOSED TO ANY THIRD PARTY WITHOUT PRIOR WRITTEN CONSENT OF LC FUTURE CENTER.				
Size	Document Number	CORAIN SWG		Rev 0.1
Date:	Thursday, October 23, 2014	Sheet	24	of 100

smd.db-x7.ru

Security Classification	LC Future Center Secret Data		Title	DDR3L BASE MEMORY CH-A (2/2)
Issued Date	2012/06/21	Deciphered Date	2012/06/21	
THIS SHEET OF ENGINEERING DRAWING IS THE PROPRIETARY PROPERTY OF LC FUTURE CENTER, AND CONTAINS CONFIDENTIAL AND TRADE SECRET INFORMATION. THIS SHEET MAY NOT BE TRANSFERRED FROM THE CUSTODY OF THE COMPETENT DIVISION OF ROAD DEPARTMENT EXCEPT AS AUTHORIZED BY LC FUTURE CENTER. NEITHER THIS SHEET NOR THE INFORMATION IT CONTAINS MAY BE USED BY OR DISCLOSED TO ANY THIRD PARTY WITHOUT PRIOR WRITTEN CONSENT OF LC FUTURE CENTER.				
Size	Document Number	Date: Thursday, October 23, 2014 (Sheet 25 of 100)		Rev 0.1
				

PLACE 1UF NEAR VCC1R35A PIN.

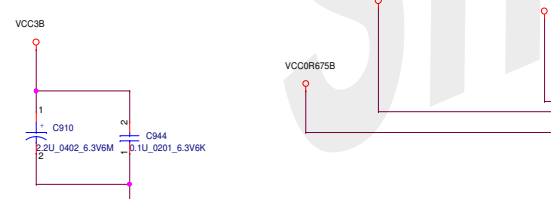
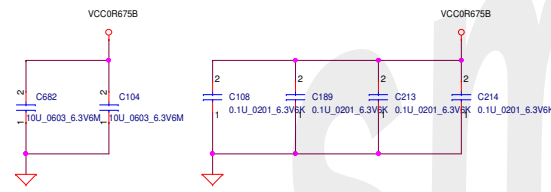
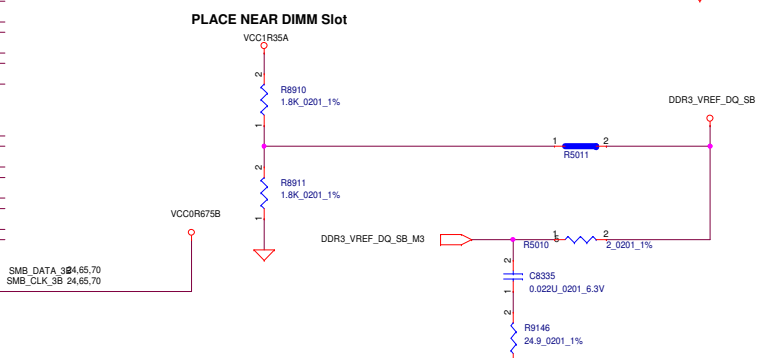
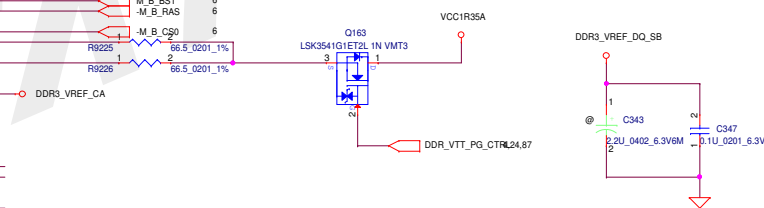
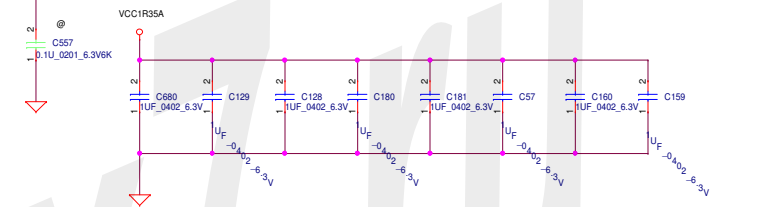
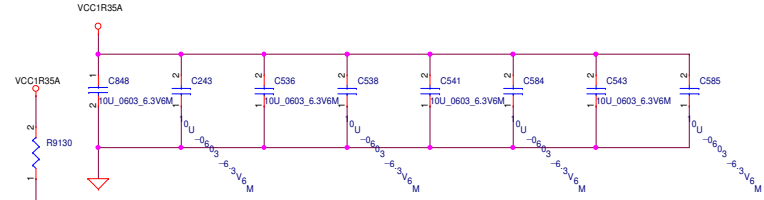
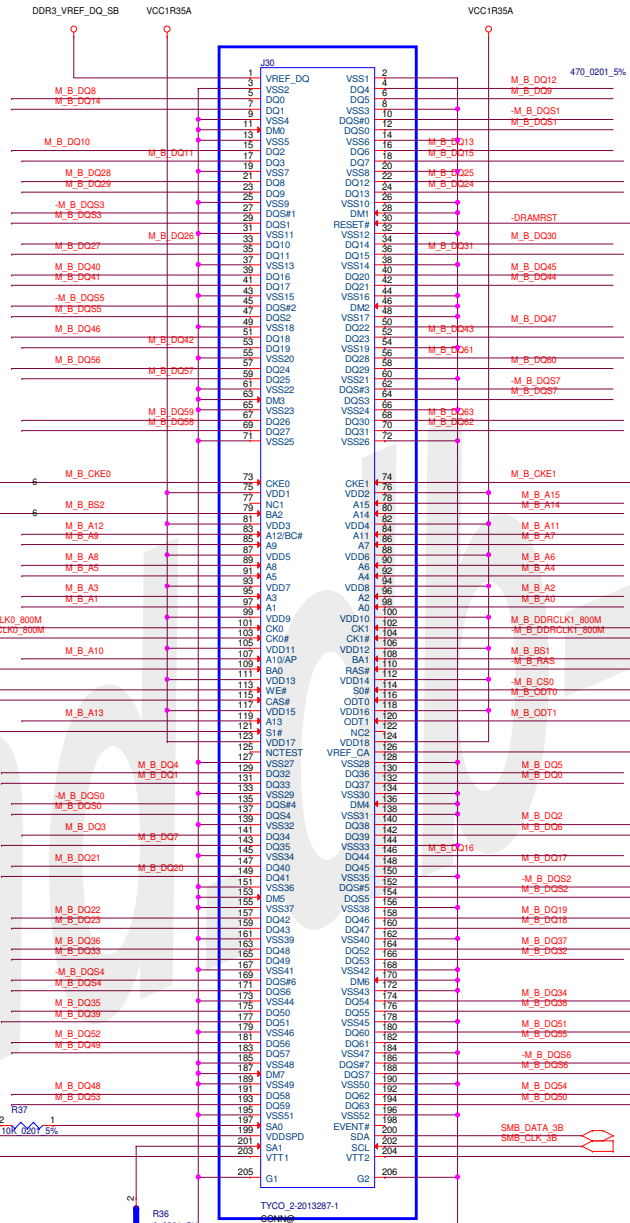
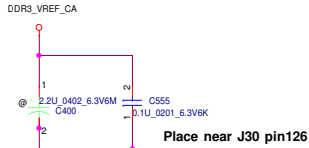
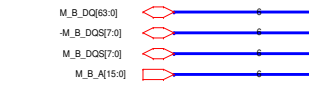

PLACE NEAR DIMM Slot

Security Classification	LC Future Center Secret Data		Title	DDR3L SO DIMM CHANNEL-B COBAIN UMA
Issued Date	2012/06/21	Deciphered Date	2012/06/21	
THIS SHEET OF ENGINEERING DRAWING IS THE PROPRIETARY PROPERTY OF LC FUTURE CENTER AND CONTAINS CONFIDENTIAL AND TRADE SECRET INFORMATION. THIS SHEET MAY NOT BE TRANSFERRED FROM THE CUSTODY OF THE COMPETENT DIVISION OF R&D DEPARTMENT EXCEPT AS AUTHORIZED BY LC FUTURE CENTER. NEITHER THIS SHEET NOR THE INFORMATION IT CONTAINS MAY BE USED BY OR DISCLOSED TO ANY THIRD PARTY WITHOUT PRIOR WRITTEN CONSENT OF LC FUTURE CENTER.				
Size	Document Number		Rev	0.1
Date:	Thursday, October 23, 2014		Sheet	26 of 100

ST-1\_SWG\_SDV\_EC173

BLANK

Security Classification	LC Future Center Secret Data		THIS BLANK	COBAIN LIMA	
Issued Date	2012/06/21	Deciphered Date			
<small>THIS SHEET OF ENGINEERING DRAWING IS THE PROPRIETARY PROPERTY OF LC FUTURE CENTER, AND CONTAINS CONFIDENTIAL AND TRADE SECRET INFORMATION. THIS SHEET MAY NOT BE TRANSFERRED FROM THE CUSTODY OF THE COMPETENT DIVISION OF R&amp;D DEPARTMENT EXCEPT AS AUTHORIZED BY LC FUTURE CENTER. NEITHER THIS SHEET NOR THE INFORMATION IT CONTAINS MAY BE USED BY OR DISCLOSED TO ANY THIRD PARTY WITHOUT PRIOR WRITTEN CONSENT OF LC FUTURE CENTER.</small>					
Size	Document Number	Rev	Date: Thursday, October 23, 2014 Sheet 27 of 100		

smd.dlp-x7.ru

BLANK

Security Classification	LC Future Center Secret Data		Title	BLANK		
Issued Date	2012/06/21	Deciphered Date	2012/06/21	COBAIN LMA		
THIS SHEET OF ENGINEERING DRAWING IS THE PROPRIETARY PROPERTY OF LC FUTURE CENTER, AND CONTAINS CONFIDENTIAL AND TRADE SECRET INFORMATION. THIS SHEET MAY NOT BE TRANSFERRED FROM THE CUSTODY OF THE COMPETENT DIVISION OF ROAD DEPARTMENT EXCEPT AS AUTHORIZED BY LC FUTURE CENTER. NEITHER THIS SHEET NOR THE INFORMATION IT CONTAINS MAY BE USED BY OR DISCLOSED TO ANY THIRD PARTY WITHOUT PRIOR WRITTEN CONSENT OF LC FUTURE CENTER.				Size	Document Number	Rev
				Customer		0.1
				Date:	Thursday, October 23, 2014	Sheet 29 of 100



BLANK

smd.dib-x7.ru

BLANK

smd.dlp-x7.ru

BLANK

smd.db-x7.ru

BLANK

smd.dlp-x7.ru

		
Project Name: COSAN Link	Title: BLANK	
Size: C	Document Number:	Rev: 0.1
Date: Thursday, October 23, 2014		Sheet: 32 of 100

BLANK

smd.db-x7.ru

BLANK

smd.db-x7.ru

BLANK

smd.dlp-x7.ru

		
Project Name:	Title: BLANK	
Size:	Document Number:	Rev: 0.1
Date: Thursday, October 23, 2014		Sheet: 35 of 100

BLANK

smd.dlp-x7.ru

		
Project Name:	Title: BLANK	
Size:	Document Number:	Rev: 0.1
Date: Thursday, October 23, 2014		Sheet: 36 of 100

SDV\_UMA\_RF\_EC004

SDV\_UMA\_RF\_EC005

SDV\_UMA\_RF\_EC006

FVT\_EMI\_Request

SDV\_UMA\_RF\_EC003

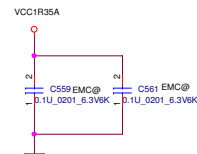
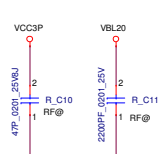
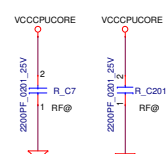
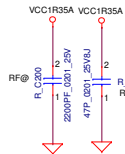
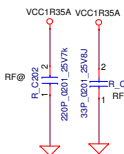

SDV\_UMA\_RF\_EC002 NEAR U58

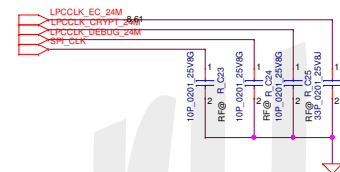

SDV\_UMA\_RF\_EC007 SDV\_UMA\_RF\_EC008

SDV\_UMA\_RF\_EC009

SDV\_UMA\_RF\_EC010

SDV\_UMA\_RF\_EC011

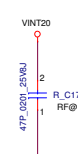
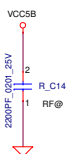
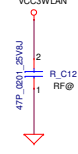
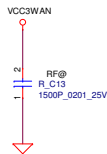
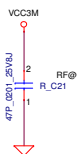

SDV\_UMA\_RF\_EC012

SDV\_UMA\_RF\_EC013

SDV\_UMA\_RF\_EC014

CB2\_FVT\_UMA\_RF

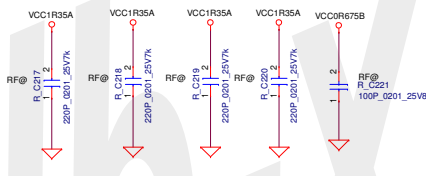
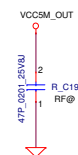
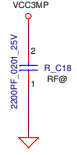
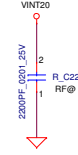

FVT\_UMA\_RF\_EC002

FVT\_UMA\_RF\_EC003

FVT\_UMA\_RF\_EC004

FVT\_UMA\_RF\_EC005

FVT\_UMA\_RF\_EC006

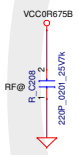
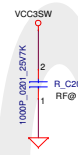
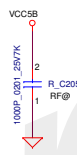
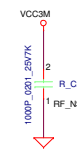
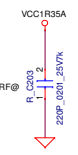

FVT\_UMA\_RF\_EC001

FVT\_UMA\_RF\_EC002

FVT\_UMA\_RF\_EC009

FVT\_UMA\_RF\_EC012

FVT\_UMA\_RF\_EC011

FVT\_UMA\_RF\_EC013

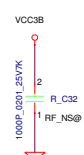
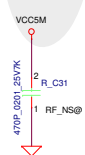
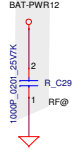
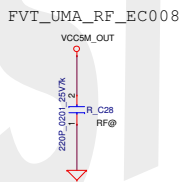
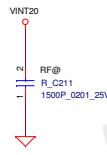
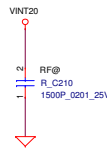

Security Classification	LC Future Center Secret Data		Title
Issued Date	2012/07/01	Deciphered Date	2014/07/01
THIS SHEET OF ENGINEERING DRAWING IS THE PROPRIETARY PROPERTY OF LC FUTURE CENTER, AND CONTAINS CONFIDENTIAL AND TRADE SECRET INFORMATION. THIS SHEET MAY NOT BE TRANSFERRED FROM THE CUSTODY OF THE COMPETENT DIVISION OF RAD DEPARTMENT EXCEPT AS AUTHORIZED BY LC FUTURE CENTER. NEITHER THIS SHEET NOR THE INFORMATION IT CONTAINS MAY BE USED BY OR DISCLOSED TO ANY THIRD PARTY WITHOUT PRIOR WRITTEN CONSENT OF LC FUTURE CENTER.			RF Component
Size	Document Number	Rev	
Date:	Thursday, October 23, 2014	Sheet	97 of 100

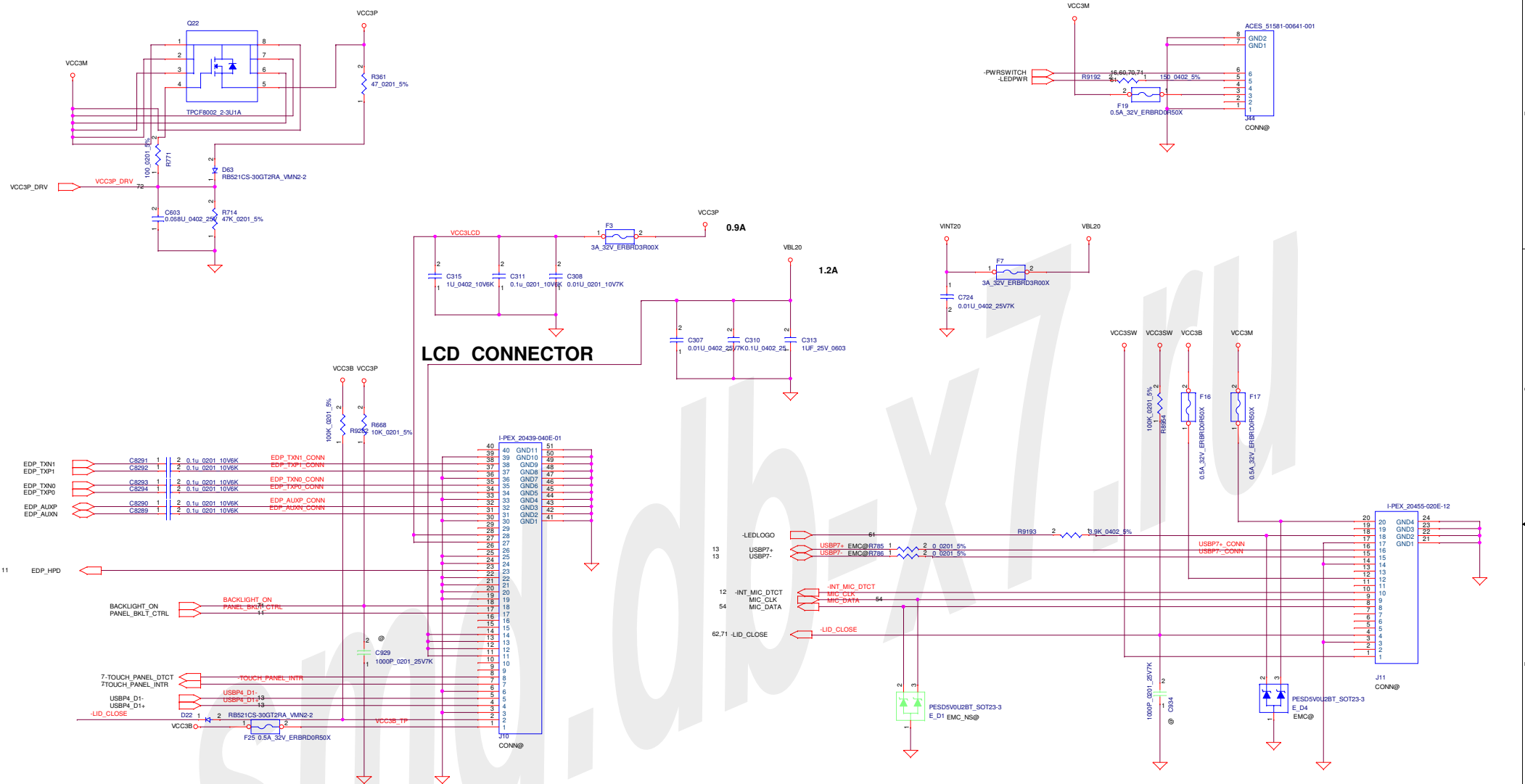

Security Classification		LC Future Center Secret Data		Title	
Issued Date	2012/07/01	Deciphered Date	2014/07/01	LCD CONNECTOR	
THIS SHEET OF ENGINEERING DRAWING IS THE PROPRIETARY PROPERTY OF LC FUTURE CENTER, AND CONTAINS CONFIDENTIAL AND TRADE SECRET INFORMATION. THIS SHEET MAY NOT BE TRANSFERRED FROM THE CUSTODY OF THE COMPETENT DIVISION OF R&D DEPARTMENT EXCEPT AS AUTHORIZED BY LC FUTURE CENTER. NEITHER THIS SHEET NOR THE INFORMATION IT CONTAINS MAY BE USED BY OR DISCLOSED TO ANY THIRD PARTY WITHOUT PRIOR WRITTEN CONSENT OF LC FUTURE CENTER.					
Size	Document Number	Date:		Thursday, October 23, 2014	Rev 0.1
Sheet	39	of	100		

BLANK

smd.dib-x7.ru

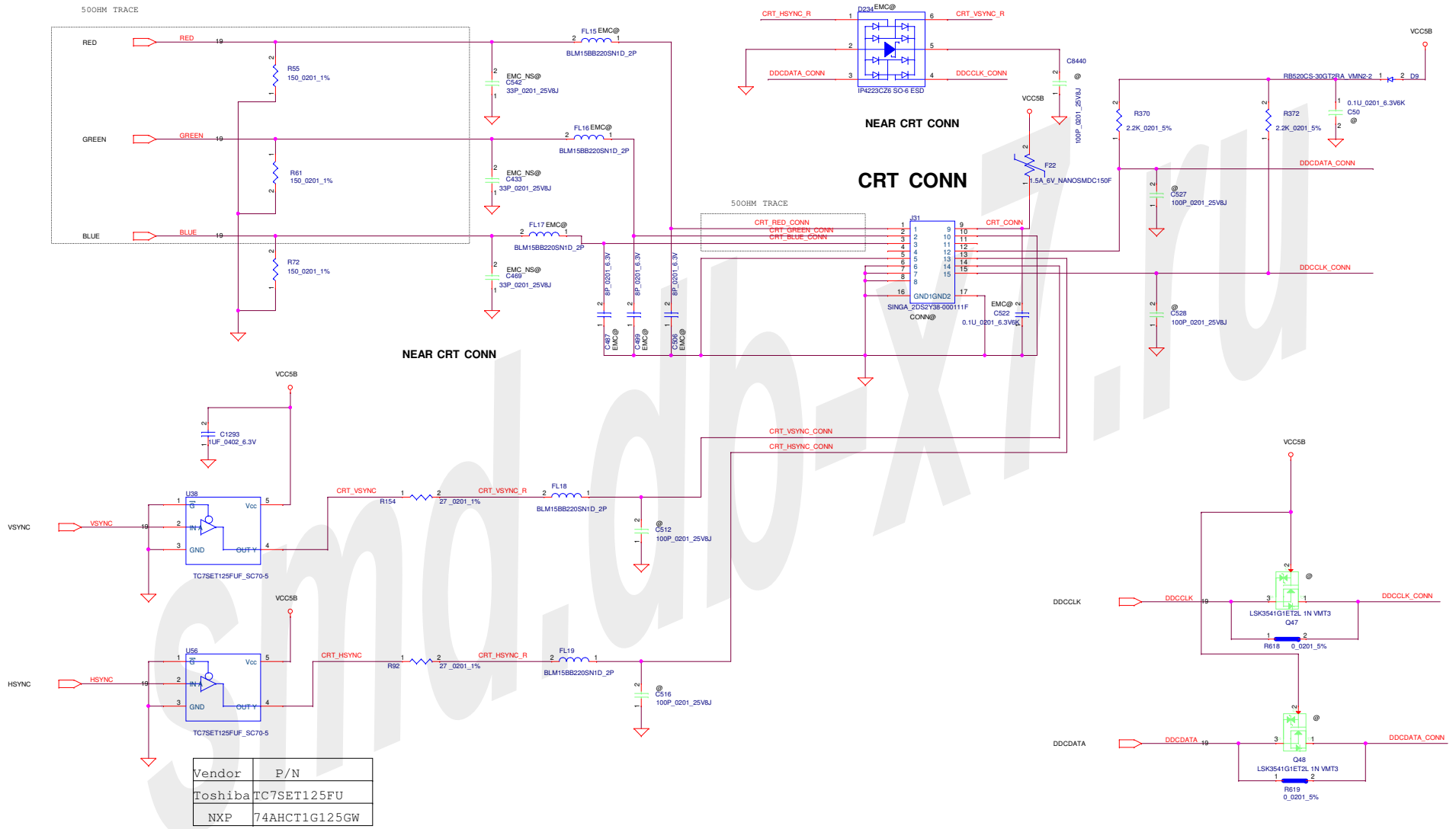

Vendor	P/N
Toshiba	TC7SET125FU
NXP	74AHCT1G125GW

Security Classification	LC Future Center Secret Data		<b>THIS EXT CRT INTERFACE</b> COBAIN LIMA	
Issued Date	2012/06/21	Deciphered Date		
<small>THIS SHEET OF ENGINEERING DRAWING IS THE PROPRIETARY PROPERTY OF LC FUTURE CENTER, AND CONTAINS CONFIDENTIAL AND TRADE SECRET INFORMATION. THIS SHEET MAY NOT BE TRANSFERRED FROM THE CUSTODY OF THE COMPETENT DIVISION OF RAD DEPARTMENT EXCEPT AS AUTHORIZED BY LC FUTURE CENTER. NEITHER THIS SHEET NOR THE INFORMATION IT CONTAINS MAY BE USED BY OR DISCLOSED TO ANY THIRD PARTY WITHOUT PRIOR WRITTEN CONSENT OF LC FUTURE CENTER.</small>				
Size	Document	Number	Rev	
Date:	Thursday, October 23, 2014	Sheet	40	of 100

Vendor	P/N
NXP	CBT3257ABQ
On-semi	74FST3257MNTWG

FOR SYSTEM DP NEAR DP CONN

DDIP1_3N	3	C339 1	2	0.1U_0201_6.3VK	DP3N
DDIP1_3P	3	C323 1	2	0.1U_0201_6.3VK	DP3P
DDIP1_2N	3	C312 1	2	0.1U_0201_6.3VK	DP2N
DDIP1_2P	3	C317 1	2	0.1U_0201_6.3VK	DP2P
DDIP1_1N	3	C277 1	2	0.1U_0201_6.3VK	DP1N
DDIP1_1P	3	C276 1	2	0.1U_0201_6.3VK	DP1P
DDIP1_0N	3	C218 1	2	0.1U_0201_6.3VK	DP0N
DDIP1_0P	3	C228 1	2	0.1U_0201_6.3VK	DP0P

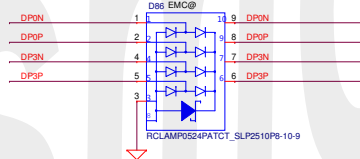
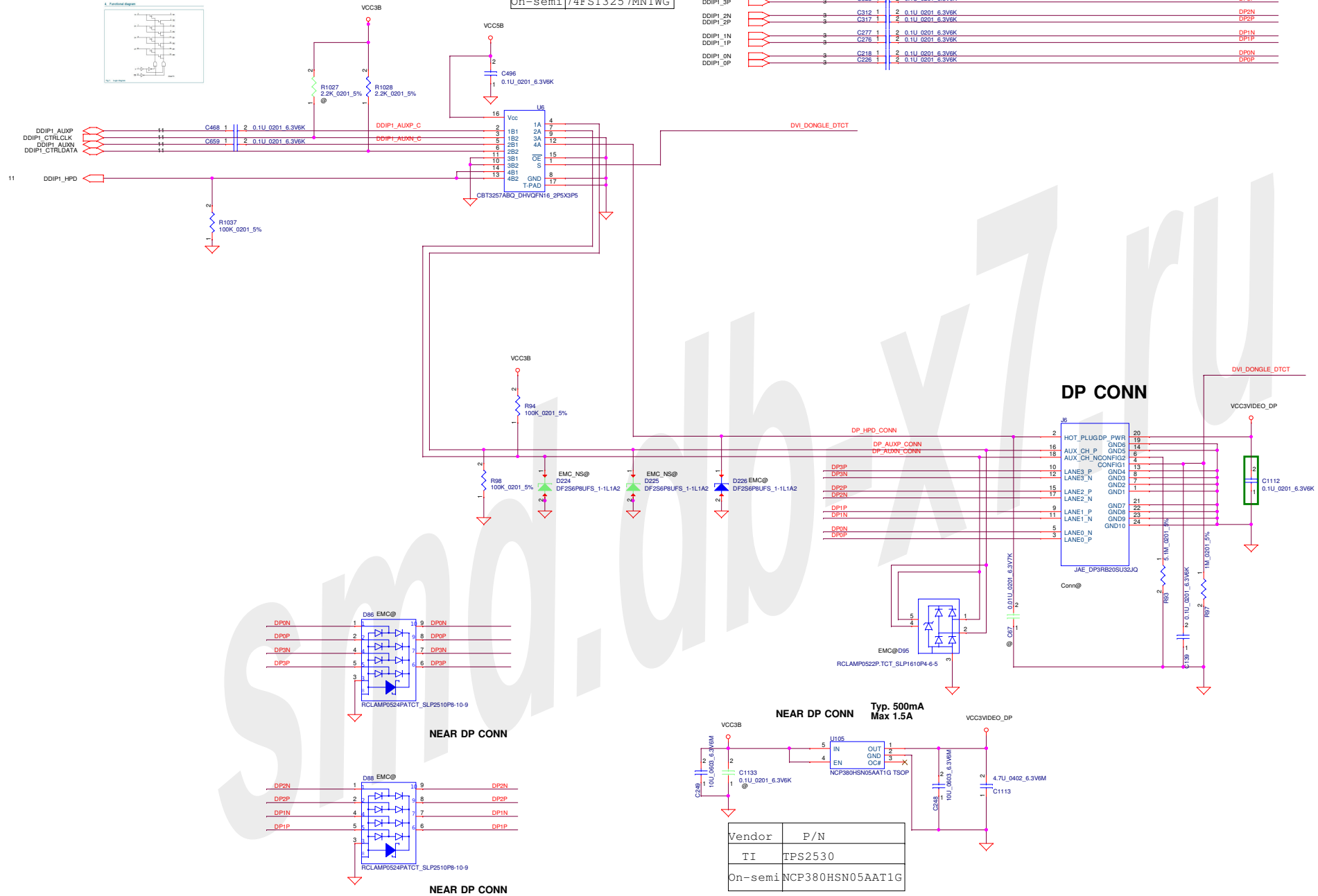
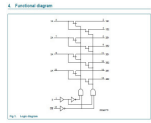

NEAR DP CONN

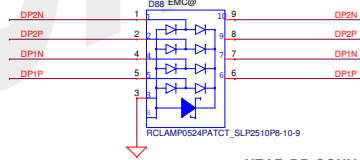

NEAR DP CONN

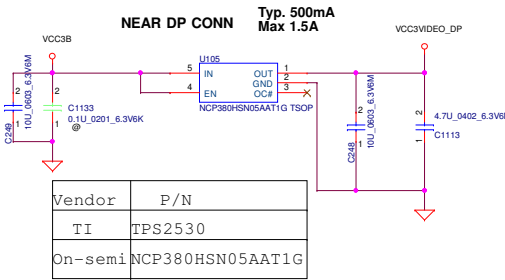

Vendor	P/N
TI	TPS2530
On-semi	NCP380HSN05AAT1G

BLANK

smd.db-x7.ru

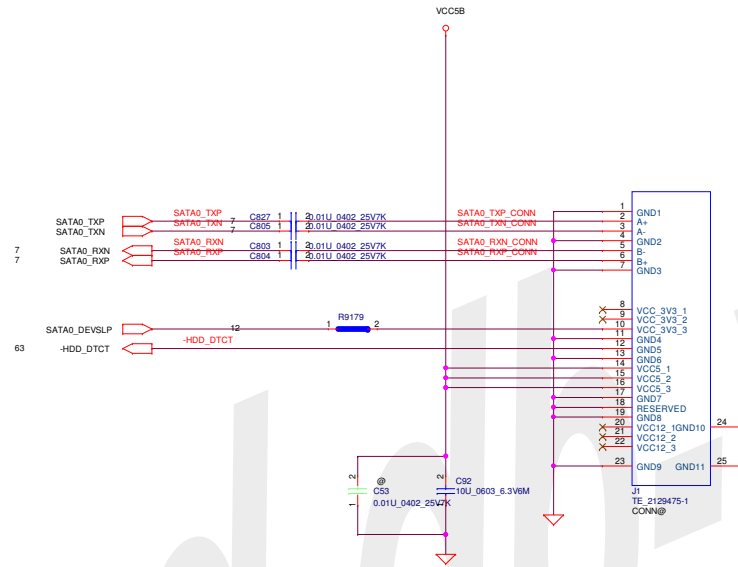

Security Classification	LC Future Center Secret Data		Title SATA HDD CONN	Customer COBAIN LIMA	
Issued Date	2012/06/21	Deciphered Date			
THIS SHEET OF ENGINEERING DRAWING IS THE PROPRIETARY PROPERTY OF LC FUTURE CENTER, AND CONTAINS CONFIDENTIAL AND TRADE SECRET INFORMATION. THIS SHEET MAY NOT BE TRANSFERRED FROM THE CUSTODY OF THE COMPETENT DIVISION OF R&D DEPARTMENT EXCEPT AS AUTHORIZED BY LC FUTURE CENTER. NEITHER THIS SHEET NOR THE INFORMATION IT CONTAINS MAY BE USED BY OR DISCLOSED TO ANY THIRD PARTY WITHOUT PRIOR WRITTEN CONSENT OF LC FUTURE CENTER.					Size Document Number Rev 01
Date: Thursday, October 23, 2014					Sheet 43 of 100

BLANK

smd.dlp-x7.ru

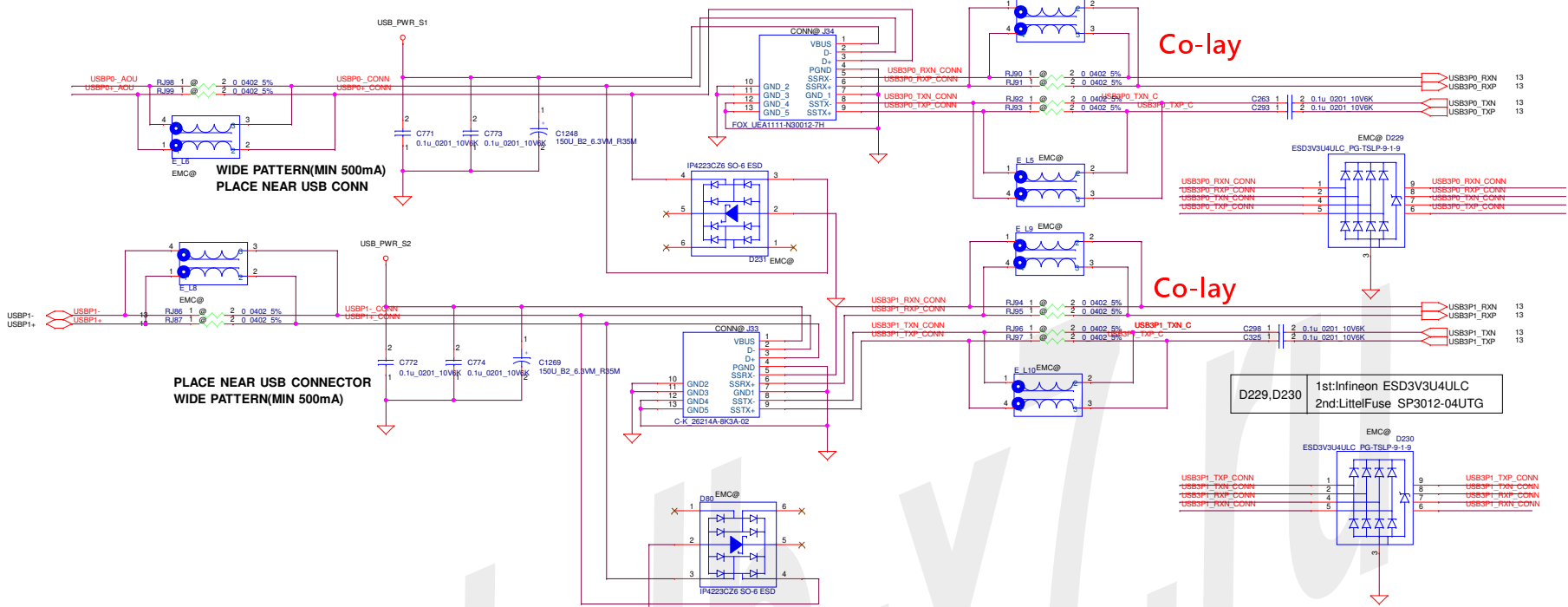

PLACE NEAR USB CONNECTOR  
WIDE PATTERN(MIN 500mA)

WIDE PATTERN(MIN 500mA)  
PLACE NEAR USB CONN

Co-lay

Co-lay

D229,D230  
1st:Infineon ESD3V3U4ULC  
2nd:LitelFuse SP3012-04UTG

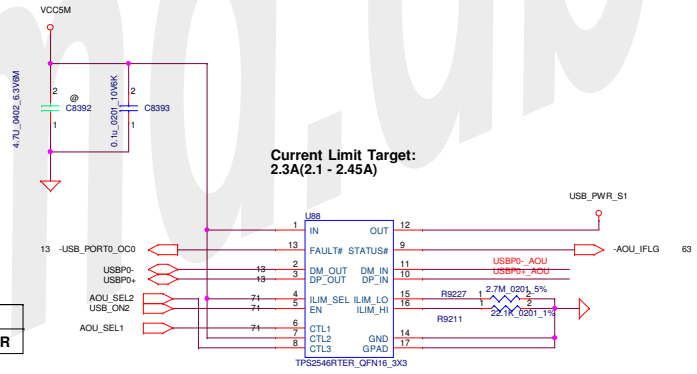

Current Limit Target:  
2.3A(2.1 - 2.45A)

U88

Vendor	P/N
TI	TPS2546RTER

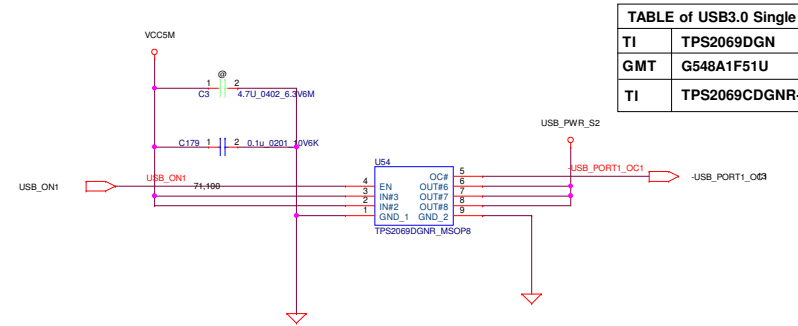
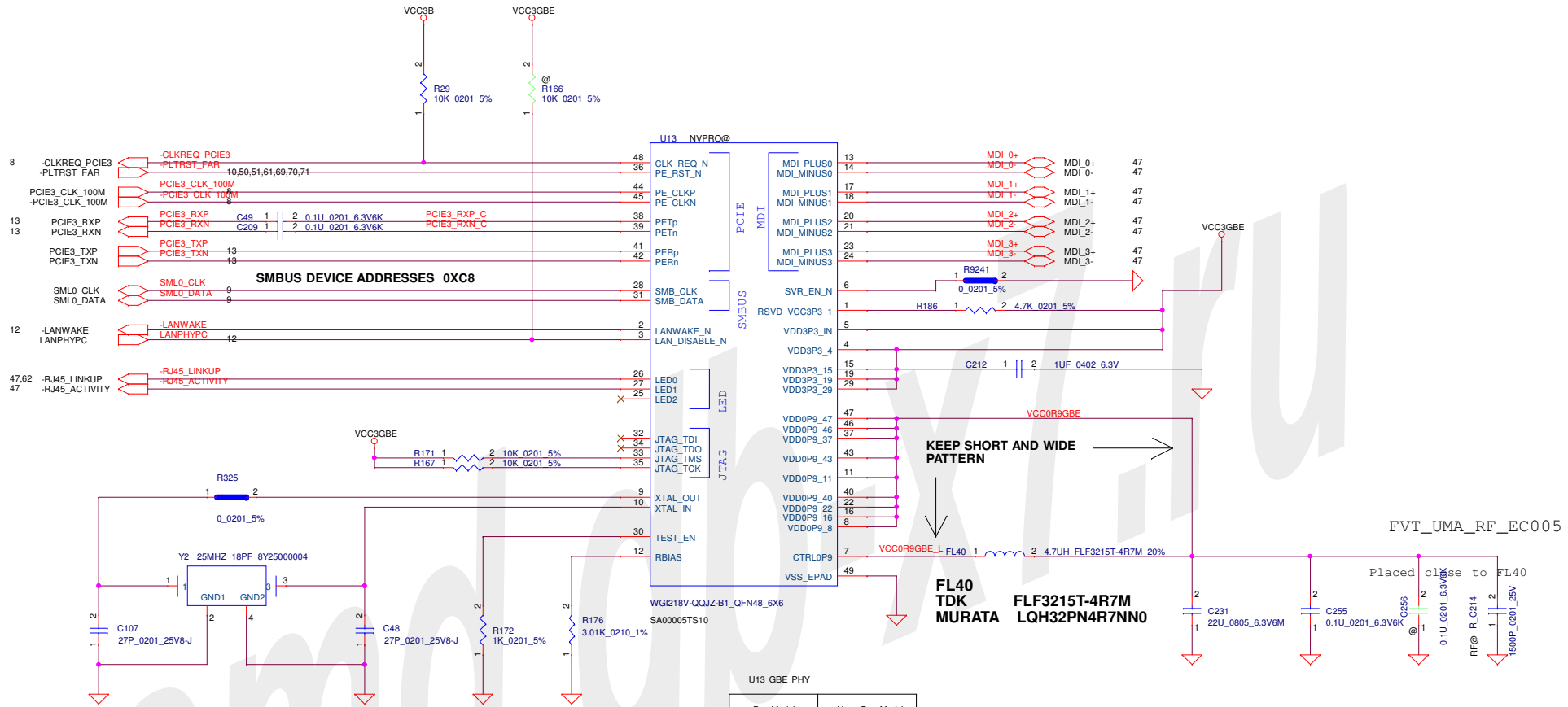

TABLE of USB3.0 Single

TI	TPS2069DGN
GMT	G548A1F51U
TI	TPS2069CDGMR-2



KDS  
TXC  
ESPON

1ZZHAE25000CC0A  
8Y25000004  
Q22FA1280023800

U13 GBE PHY

vPro Model	Non-vPro Model
I218LM	I218V

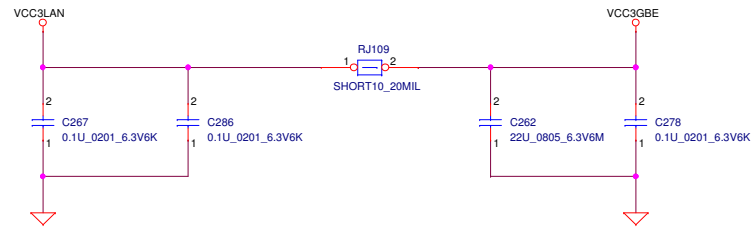

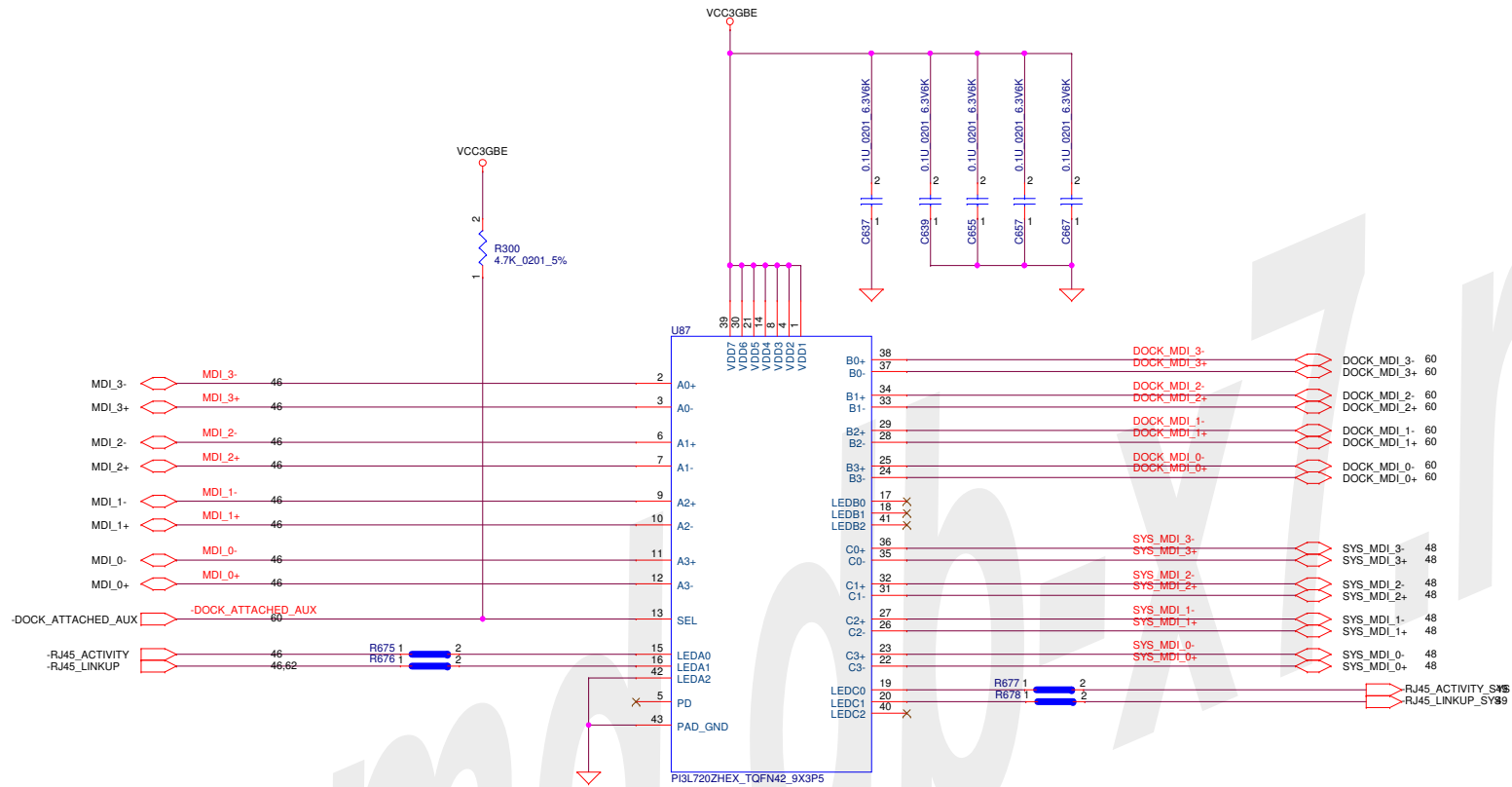

U87

Vendor	P/N
Pericom ST micro Onsemi	PI3L720ZHE STMUX1800E NCN7201

Security Classification	LC Future Center Secret Data		Title
Issued Date	2012/05/01	Deciphered Date	2012/12/01
THIS SHEET OF ENGINEERING DRAWING IS THE PROPRIETARY PROPERTY OF LC FUTURE CENTER, AND CONTAINS CONFIDENTIAL AND TRADE SECRET INFORMATION. THIS SHEET MAY NOT BE TRANSFERRED FROM THE CUSTODY OF THE COMPETENT DIVISION OF R&D DEPARTMENT EXCEPT AS AUTHORIZED BY LC FUTURE CENTER NEITHER THIS SHEET NOR THE INFORMATION IT CONTAINS MAY BE USED BY OR DISCLOSED TO ANY THIRD PARTY WITHOUT PRIOR WRITTEN CONSENT OF LC FUTURE CENTER.			

Size	Document Number	Rev
Custom	<b>COBAIN UMA</b>	0.1
Date:	Thursday, October 23, 2014	Sheet 47 of 100



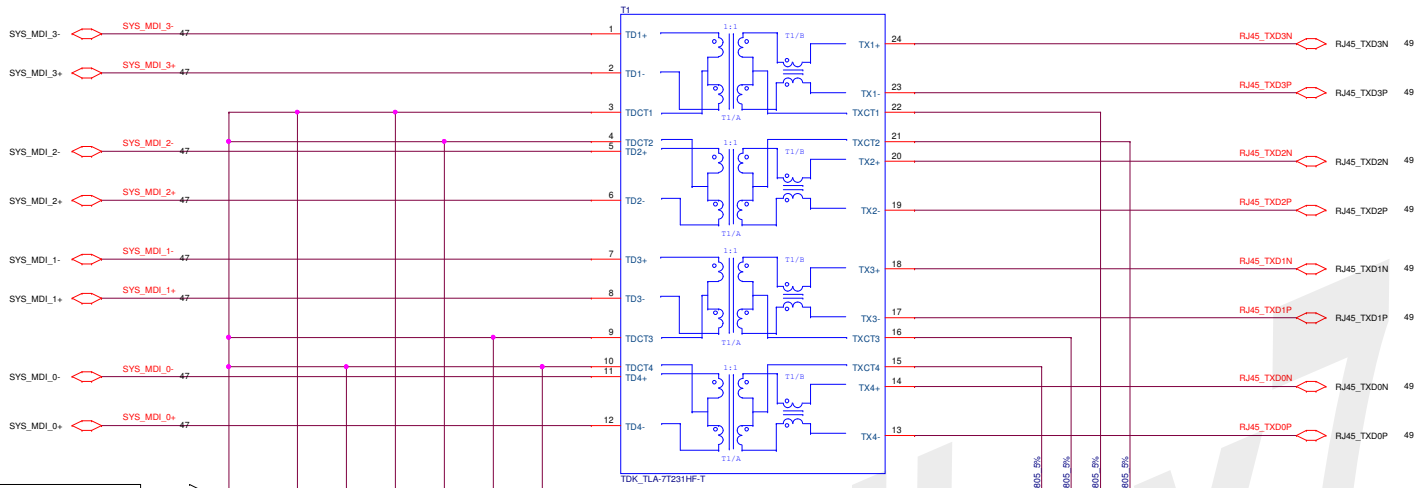

THE WIDTH OF THESE TRACE SHOULD BE WIDER THAN 35MIL TO PREVENT VOLTAGE DROP.

C303 SHOULD BE PLACED AS CLOSE TO MAGNETICS AS POSSIBLE.

ESD REASON

PATTERN MUST BE SHORT AND WIDE.

HIGH VOLTAGE 1500PF CAP IS OPTIONAL

Vendor	P/N
TDK	TLA-7T231HF-T
Timag	IH-115-F
Bothhand	NA69LF
TDK	TLA-7T201HF-T

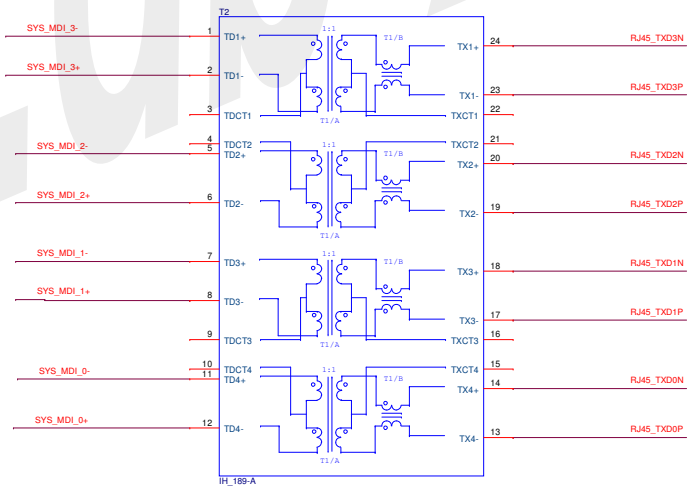

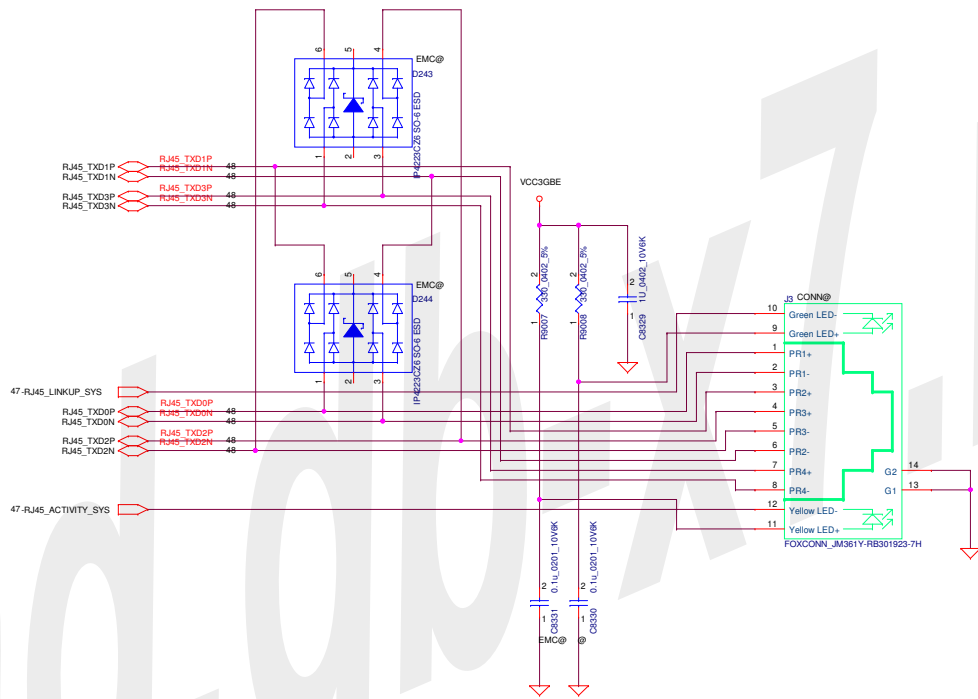

Security Classification		LC Future Center Secret Data		Title	
Issued Date	2012/05/02	Deciphered Date	2012/5/02	RJ45 CONNECTOR	
THIS SHEET OF ENGINEERING DRAWING IS THE PROPRIETARY PROPERTY OF LC FUTURE CENTER, AND CONTAINS CONFIDENTIAL AND TRADE SECRET INFORMATION. THIS SHEET MAY NOT BE TRANSFERRED FROM THE CUSTODY OF THE COMPETENT DIVISION OF R&D DEPARTMENT EXCEPT AS AUTHORIZED BY LC FUTURE CENTER. NEITHER THIS SHEET NOR THE INFORMATION IT CONTAINS MAY BE USED BY OR DISCLOSED TO ANY THIRD PARTY WITHOUT PRIOR WRITTEN CONSENT OF LC FUTURE CENTER.					
Size	Document Number	Customer		Rev	
	COBA IN IMA			01	
Date:	Thursday, October 23, 2014	Sheet	49	of	100



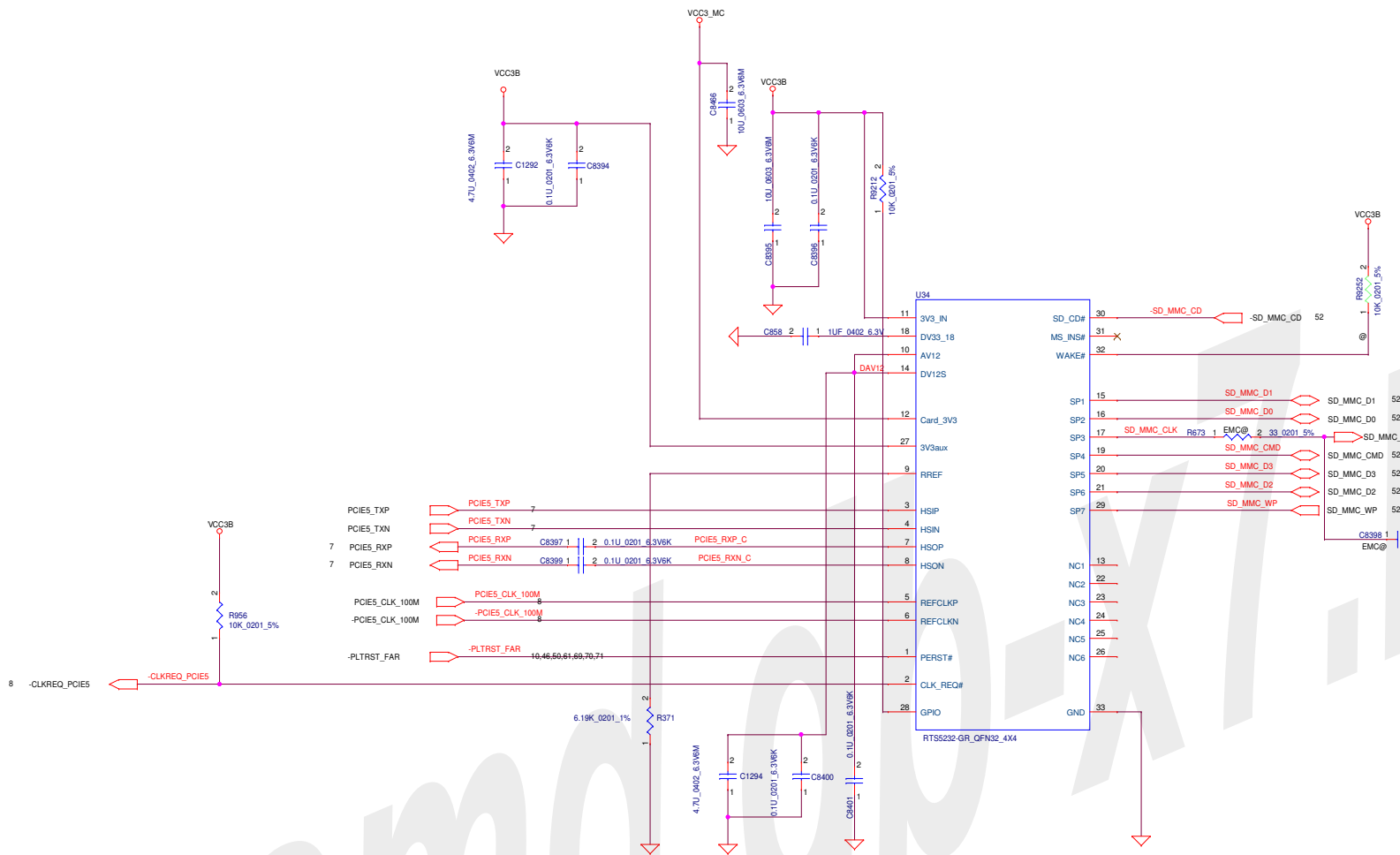



Security Classification	LC Future Center Secret Data	
Issued Date	2012/05/01	Deciphered Date
		2012/12/01

Title		
MEDIA CARD CONTROLLER		
Size	Document Number	Rev
C	COBAIN UMA	0.1
Date:	Thursday, October 23, 2014	Sheet 51 of 100

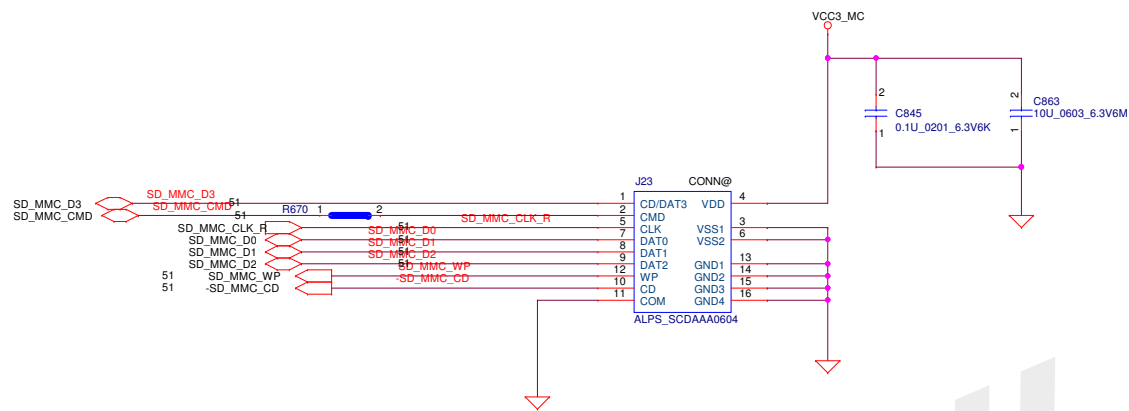
THIS SHEET OF ENGINEERING DRAWING IS THE PROPRIETARY PROPERTY OF LC FUTURE CENTER, AND CONTAINS CONFIDENTIAL AND TRADE SECRET INFORMATION. THIS SHEET MAY NOT BE TRANSFERRED FROM THE CUSTODY OF THE COMPETENT DIVISION OF R&D DEPARTMENT EXCEPT AS AUTHORIZED BY LC FUTURE CENTER. NEITHER THIS SHEET NOR THE INFORMATION IT CONTAINS MAY BE USED BY OR DISCLOSED TO ANY THIRD PARTY WITHOUT PRIOR WRITTEN CONSENT OF LC FUTURE CENTER.



smd.db-x7.ru

Security Classification		LC Future Center Secret Data		Title		
Issued Date	2012/05/01	Deciphered Date	2012/12/01	MEDIA CARD INTERFACE		
<small>THIS SHEET OF ENGINEERING DRAWING IS THE PROPRIETARY PROPERTY OF LC FUTURE CENTER, AND CONTAINS CONFIDENTIAL AND TRADE SECRET INFORMATION. THIS SHEET MAY NOT BE TRANSFERRED FROM THE CUSTODY OF THE COMPETENT DIVISION OF R&amp;D DEPARTMENT EXCEPT AS AUTHORIZED BY LC FUTURE CENTER NEITHER THIS SHEET NOR THE INFORMATION IT CONTAINS MAY BE USED BY OR DISCLOSED TO ANY THIRD PARTY WITHOUT PRIOR WRITTEN CONSENT OF LC FUTURE CENTER.</small>				Size	Document Number	Rev
				Custom	<b>COBAIN UMA</b>	0.1
				Date:	Thursday, October 23, 2014	Sheet 52 of 100

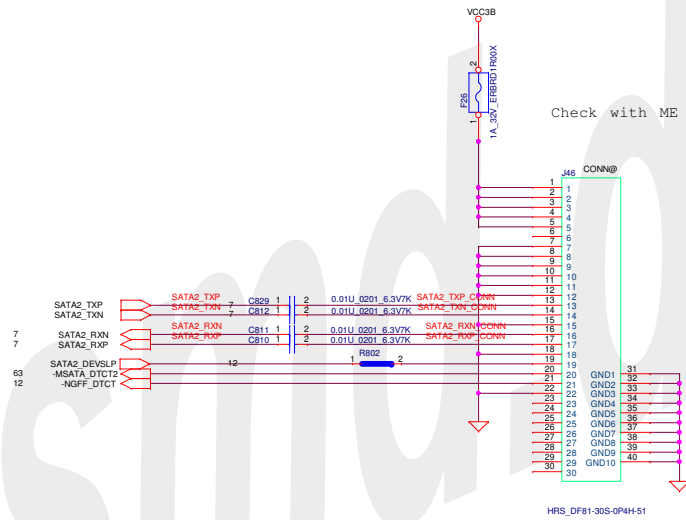
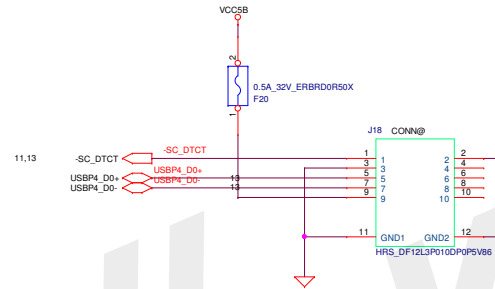
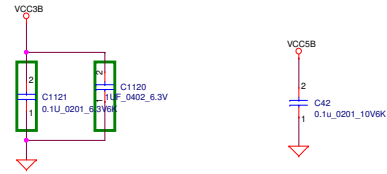

Security Classification	LC Future Center Secret Data		Title	SMART CARD I/F
Issued Date	2012/07/01	Deciphered Date	2014/07/01	
THIS SHEET OF ENGINEERING DRAWING IS THE PROPRIETARY PROPERTY OF LC FUTURE CENTER, AND CONTAINS CONFIDENTIAL AND TRADE SECRET INFORMATION. THIS SHEET MAY NOT BE TRANSFERRED FROM THE CUSTODY OF THE COMPETENT DIVISION OF R&D DEPARTMENT EXCEPT AS AUTHORIZED BY LC FUTURE CENTER. NEITHER THIS SHEET NOR THE INFORMATION IT CONTAINS MAY BE USED BY OR DISCLOSED TO ANY THIRD PARTY WITHOUT PRIOR WRITTEN CONSENT OF LC FUTURE CENTER.				
Size	Document Number	Rev		
Date:	Thursday, October 23, 2014	Sheet	53	of 100



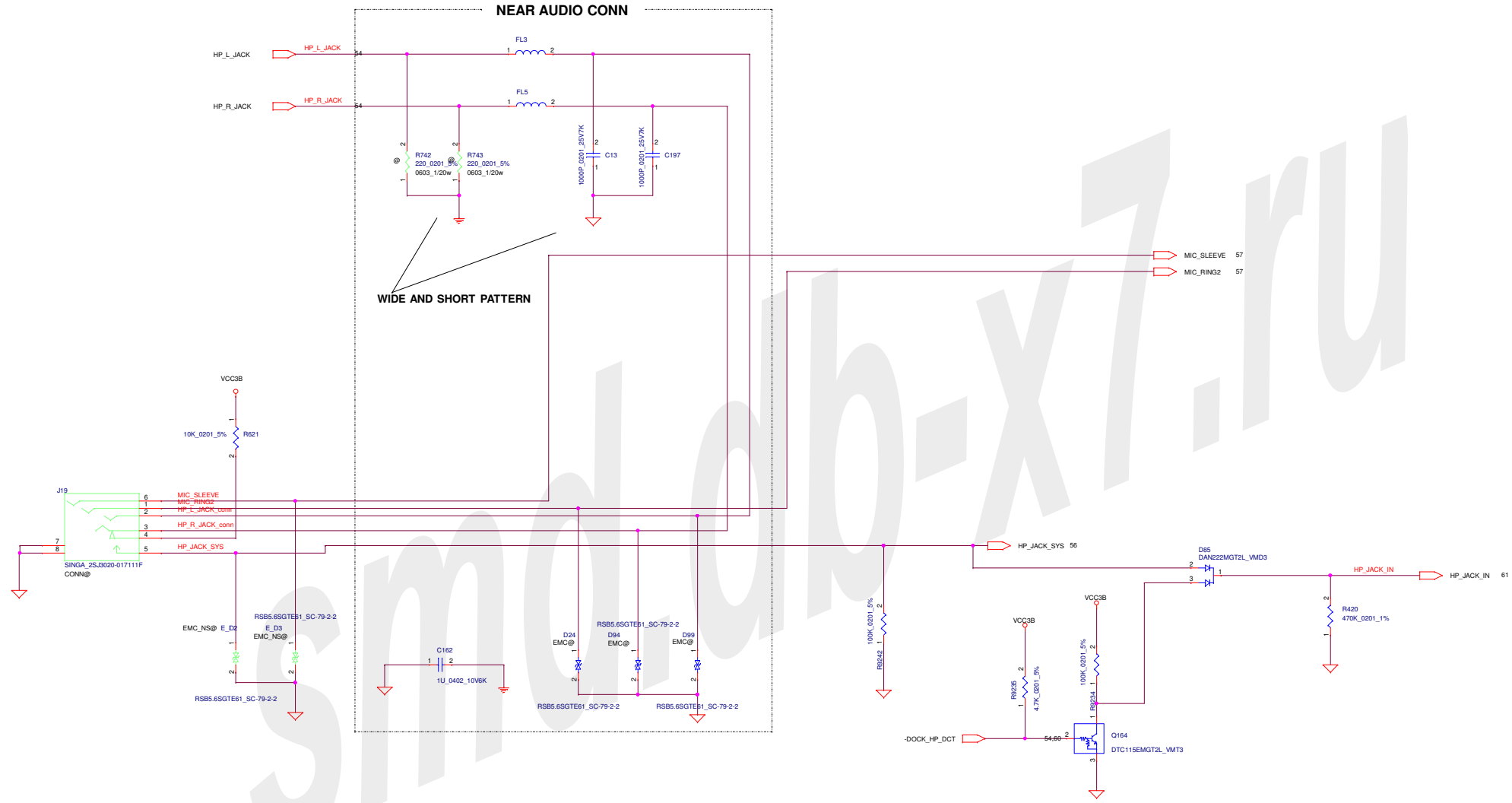



Security Classification	LC Future Center Secret Data		Title	
Issued Date	2012/05/02	Deciphered Date	2012/5/02	
THIS SHEET OF ENGINEERING DRAWING IS THE PROPRIETARY PROPERTY OF LC FUTURE CENTER, AND CONTAINS CONFIDENTIAL AND TRADE SECRET INFORMATION. THIS SHEET MAY NOT BE TRANSFERRED FROM THE CUSTODY OF THE COMPETENT DIVISION OF R&D DEPARTMENT EXCEPT AS AUTHORIZED BY LC FUTURE CENTER. NEITHER THIS SHEET NOR THE INFORMATION IT CONTAINS MAY BE USED BY OR DISCLOSED TO ANY THIRD PARTY WITHOUT PRIOR WRITTEN CONSENT OF LC FUTURE CENTER.				Size: 0.1 Document Number: C Date: Thursday, October 23, 2014 Sheet: 55 of 100

**AUDIO CONNECTOR**

**COBA IN IMA**

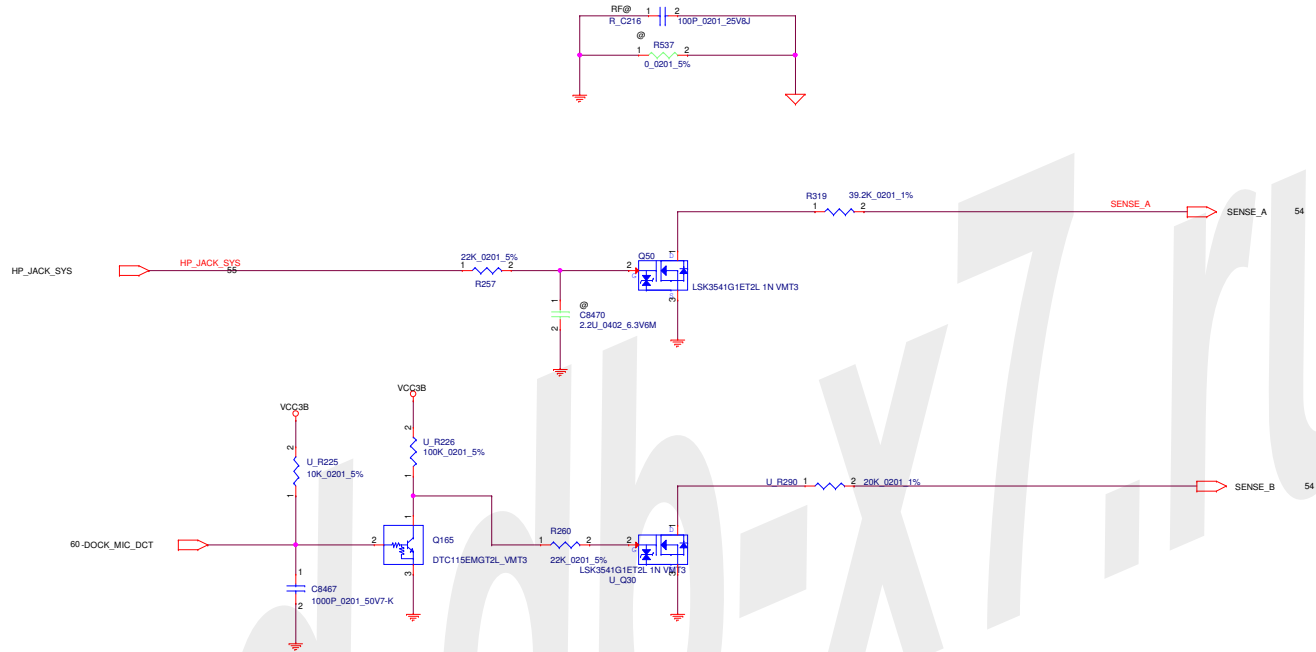
FVT\_UMA\_RF\_EC007



Security Classification	LC Future Center Secret Data		Title	 
Issued Date	2012/05/02	Deciphered Date	2012/5/02	
<small>THIS SHEET OF ENGINEERING DRAWING IS THE PROPRIETARY PROPERTY OF LC FUTURE CENTER, AND CONTAINS CONFIDENTIAL AND TRADE SECRET INFORMATION. THIS SHEET MAY NOT BE TRANSFERRED FROM THE CUSTODY OF THE COMPETENT DIVISION OF R&amp;D DEPARTMENT EXCEPT AS AUTHORIZED BY LC FUTURE CENTER. NEITHER THIS SHEET NOR THE INFORMATION IT CONTAINS MAY BE USED BY OR DISCLOSED TO ANY THIRD PARTY WITHOUT PRIOR WRITTEN CONSENT OF LC FUTURE CENTER.</small>				Size: C Document Number: <b>COBA IN UMA</b> Date: Thursday, October 23, 2014 (Sheet 56 of 100)

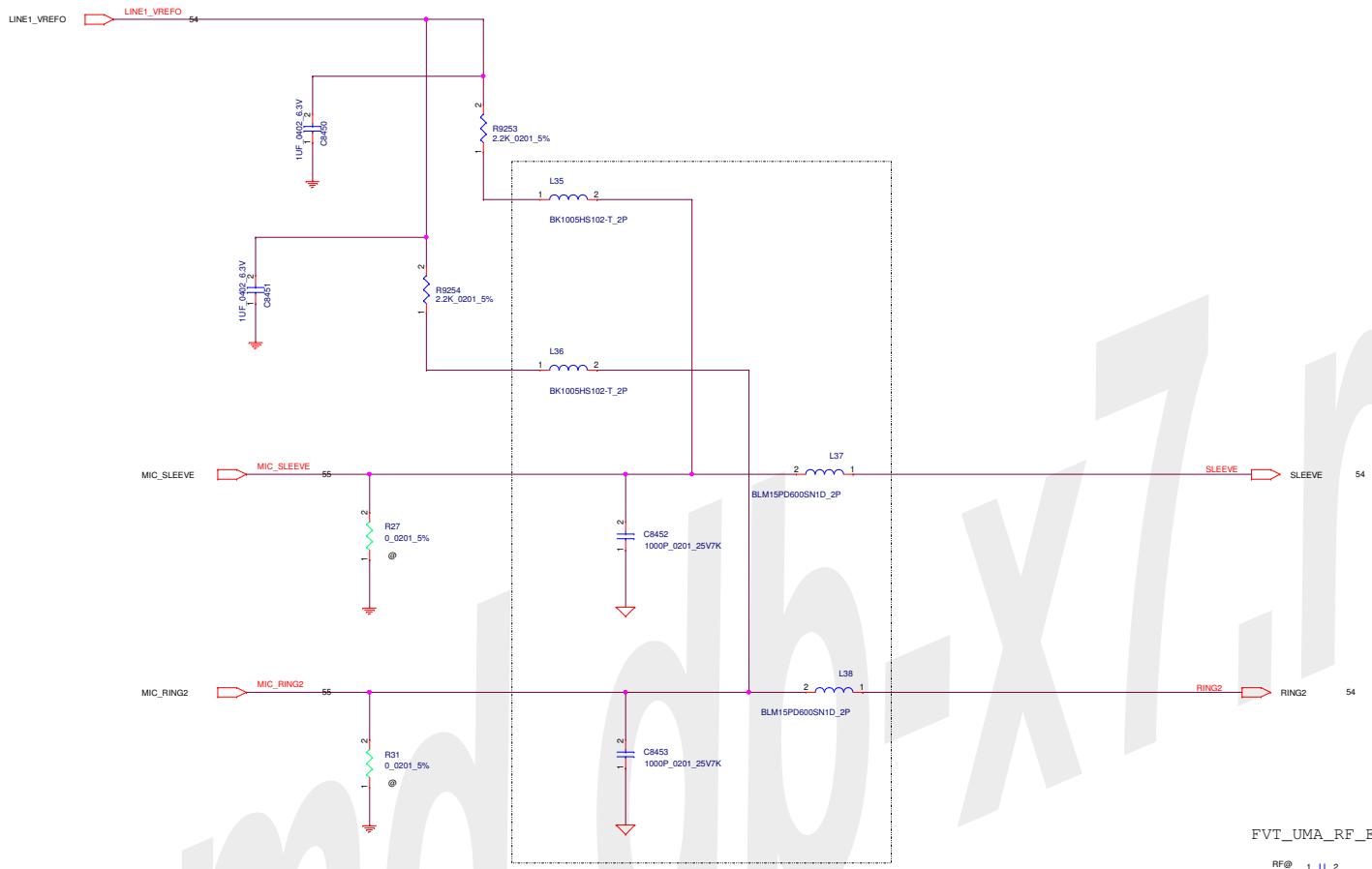

FVT\_UMA\_RF\_EC006

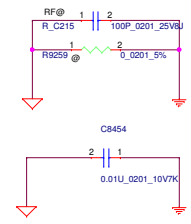

Security Classification	LC Future Center Secret Data		Title	AUDIO EXT MIC I/F
Issued Date	2012/06/21	Deciphered Date		
<small>THIS SHEET OF ENGINEERING DRAWING IS THE PROPRIETARY PROPERTY OF LC FUTURE CENTER, AND CONTAINS CONFIDENTIAL AND TRADE SECRET INFORMATION. THIS SHEET MAY NOT BE TRANSFERRED FROM THE CUSTODY OF THE COMPETENT DIVISION OF R&amp;D DEPARTMENT EXCEPT AS AUTHORIZED BY LC FUTURE CENTER. NEITHER THIS SHEET NOR THE INFORMATION IT CONTAINS MAY BE USED BY OR DISCLOSED TO ANY THIRD PARTY WITHOUT PRIOR WRITTEN CONSENT OF LC FUTURE CENTER.</small>				
Size	Document Number	Customer		Rev
Date:	Thursday, October 23, 2014	Sheet	57	of 100



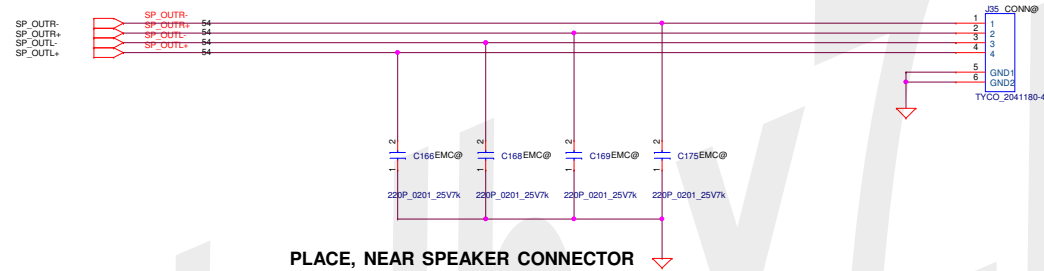

smd.dip-xtr.u

Security Classification	LC Future Center Secret Data		Title	
Issued Date	2012/05/02	Deciphered Date	2012/5/02	
<small>THIS SHEET OF ENGINEERING DRAWING IS THE PROPRIETARY PROPERTY OF LC FUTURE CENTER, AND CONTAINS CONFIDENTIAL AND TRADE SECRET INFORMATION. THIS SHEET MAY NOT BE TRANSFERRED FROM THE CUSTODY OF THE COMPETENT DIVISION OF R&amp;D DEPARTMENT EXCEPT AS AUTHORIZED BY LC FUTURE CENTER. NEITHER THIS SHEET NOR THE INFORMATION IT CONTAINS MAY BE USED BY OR DISCLOSED TO ANY THIRD PARTY WITHOUT PRIOR WRITTEN CONSENT OF LC FUTURE CENTER.</small>				Size Document Number Custom C <b>COBA IN IMA</b> Rev 0.1
Date: Thursday, October 23, 2014				Sheet 59 of 100

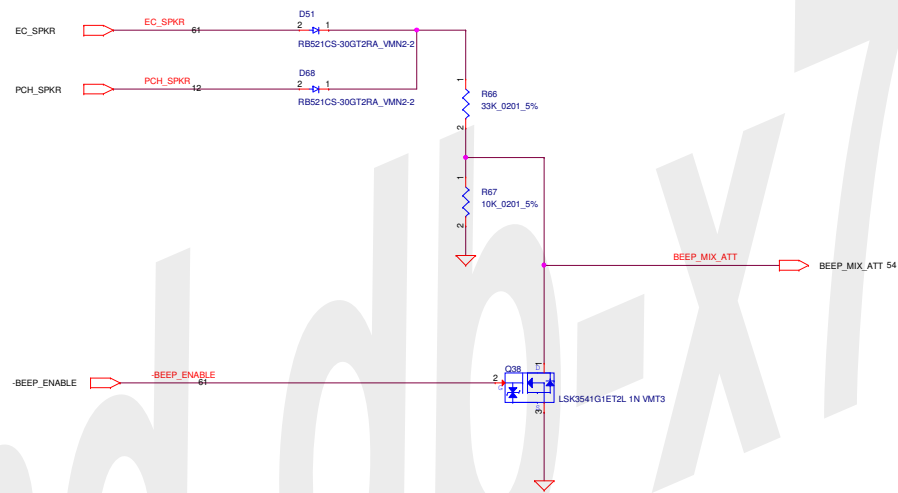

smd.dip-x7.ru

Security Classification	LC Future Center Secret Data		Title	
Issued Date	2012/05/02	Deciphered Date	2012/5/02	
<small>THIS SHEET OF ENGINEERING DRAWING IS THE PROPRIETARY PROPERTY OF LC FUTURE CENTER, AND CONTAINS CONFIDENTIAL AND TRADE SECRET INFORMATION. THIS SHEET MAY NOT BE TRANSFERRED FROM THE CUSTODY OF THE COMPETENT DIVISION OF R&amp;D DEPARTMENT EXCEPT AS AUTHORIZED BY LC FUTURE CENTER. NEITHER THIS SHEET NOR THE INFORMATION IT CONTAINS MAY BE USED BY OR DISCLOSED TO ANY THIRD PARTY WITHOUT PRIOR WRITTEN CONSENT OF LC FUTURE CENTER.</small>				Size Document Number Custom <b>COBA IN UMA</b> Rev 0.1
Date: Thursday, October 23, 2014				Sheet 99 of 100

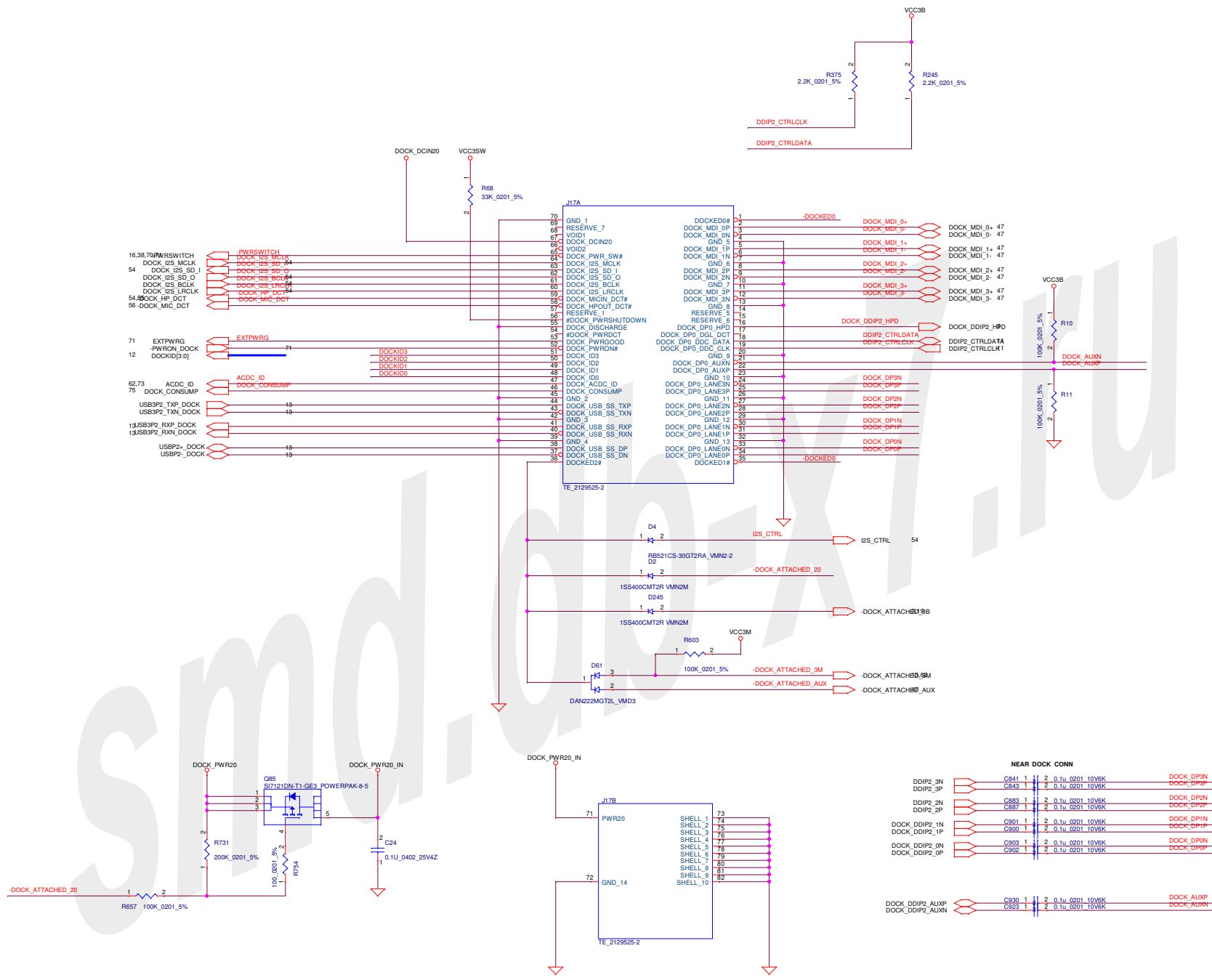

Security Classification		LC Future Center Secret Data		Title	
Issued Date	2012/05/02	Deciphered Date	2012/5/02	DOCKING CONNECTOR	
THIS SHEET OF ENGINEERING DRAWING IS THE PROPRIETARY PROPERTY OF LC FUTURE CENTER, AND CONTAINS CONFIDENTIAL AND TRADE SECRET INFORMATION. THIS SHEET MAY NOT BE TRANSFERRED FROM THE CUSTODY OF THE COMPETENT DIVISION OF R&D DEPARTMENT EXCEPT AS AUTHORIZED BY LC FUTURE CENTER. NEITHER THIS SHEET NOR THE INFORMATION IT CONTAINS MAY BE USED BY OR DISCLOSED TO ANY THIRD PARTY WITHOUT PRIOR WRITTEN CONSENT OF LC FUTURE CENTER.					
Size	Document Number	Rev		Rev	
	CORA IN UMA	01		01	
Date:	Thursday, October 23, 2014	Sheet	60	of	100

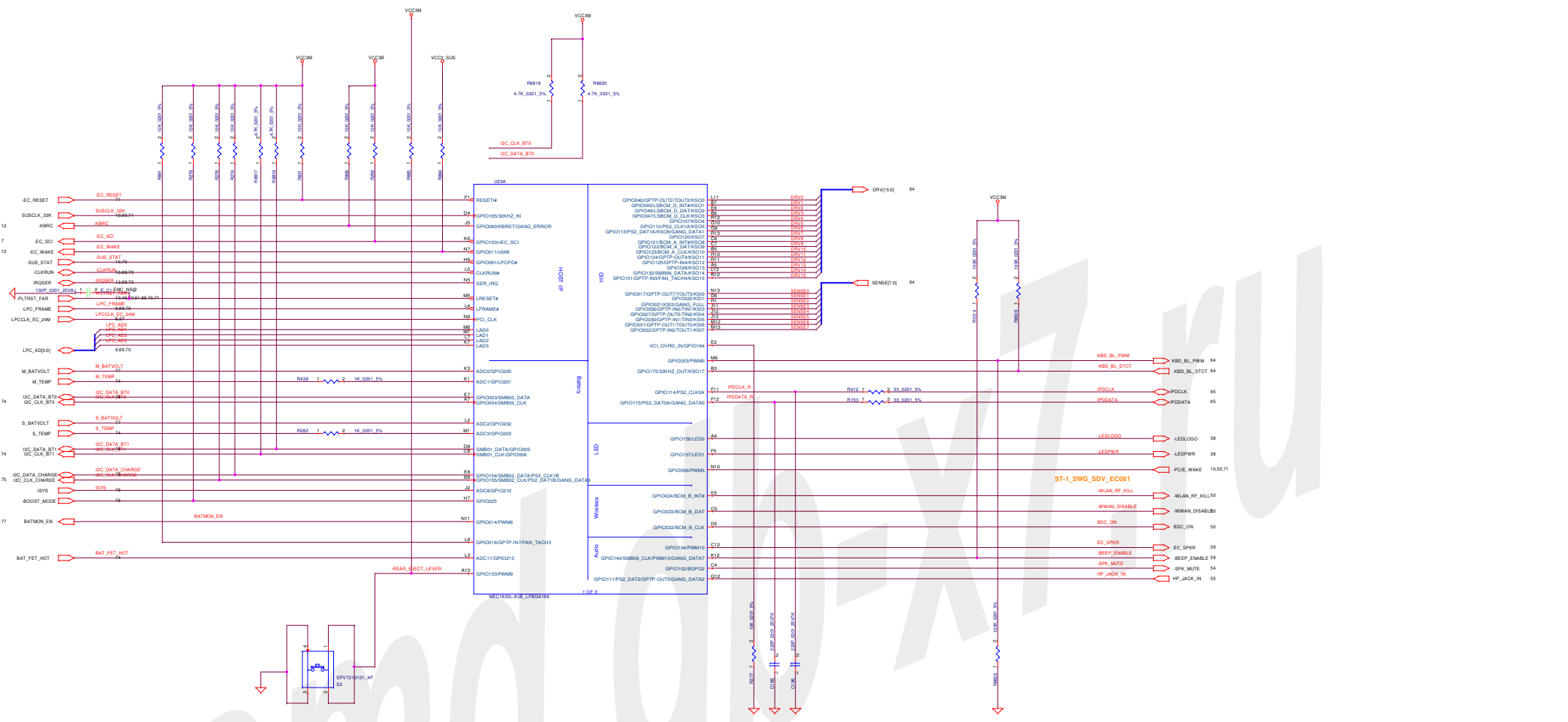

Security Classification	LC Future Center Secret Data		Title
Issued Date	2012/05/01	Discontinued Date	2012/12/01
			EC - ME16331 (1/3)
Doc No.	Document Number	Doc No.	ME16331
			REV 01

THIS SHEET OF ENGINEERING DRAWING IS THE PROPRIETARY PROPERTY OF LC FUTURE CENTER AND IS CONFIDENTIAL. ANY UNAUTHORIZED REPRODUCTION OR DISSEMINATION OF THIS SHEET IS STRICTLY PROHIBITED. THE CONTENTS OF THIS SHEET ARE NOT TO BE REPRODUCED OR TRANSMITTED IN ANY FORM OR BY ANY MEANS, ELECTRONIC OR MECHANICAL, INCLUDING PHOTOCOPYING, RECORDING, OR BY ANY INFORMATION STORAGE AND RETRIEVAL SYSTEM. THE CONTENTS OF THIS SHEET ARE NOT TO BE REPRODUCED OR TRANSMITTED IN ANY FORM OR BY ANY MEANS, ELECTRONIC OR MECHANICAL, INCLUDING PHOTOCOPYING, RECORDING, OR BY ANY INFORMATION STORAGE AND RETRIEVAL SYSTEM.

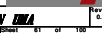

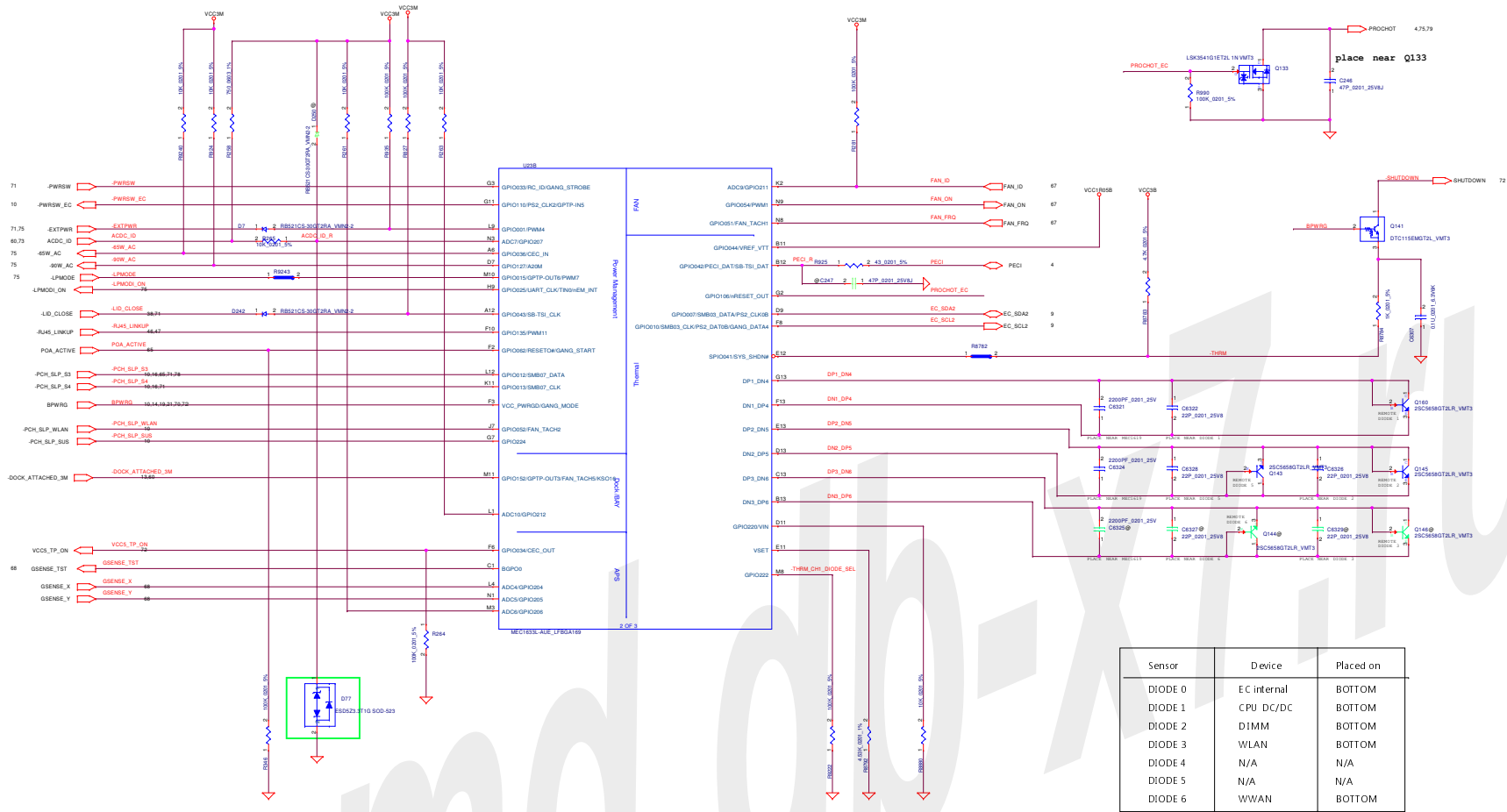

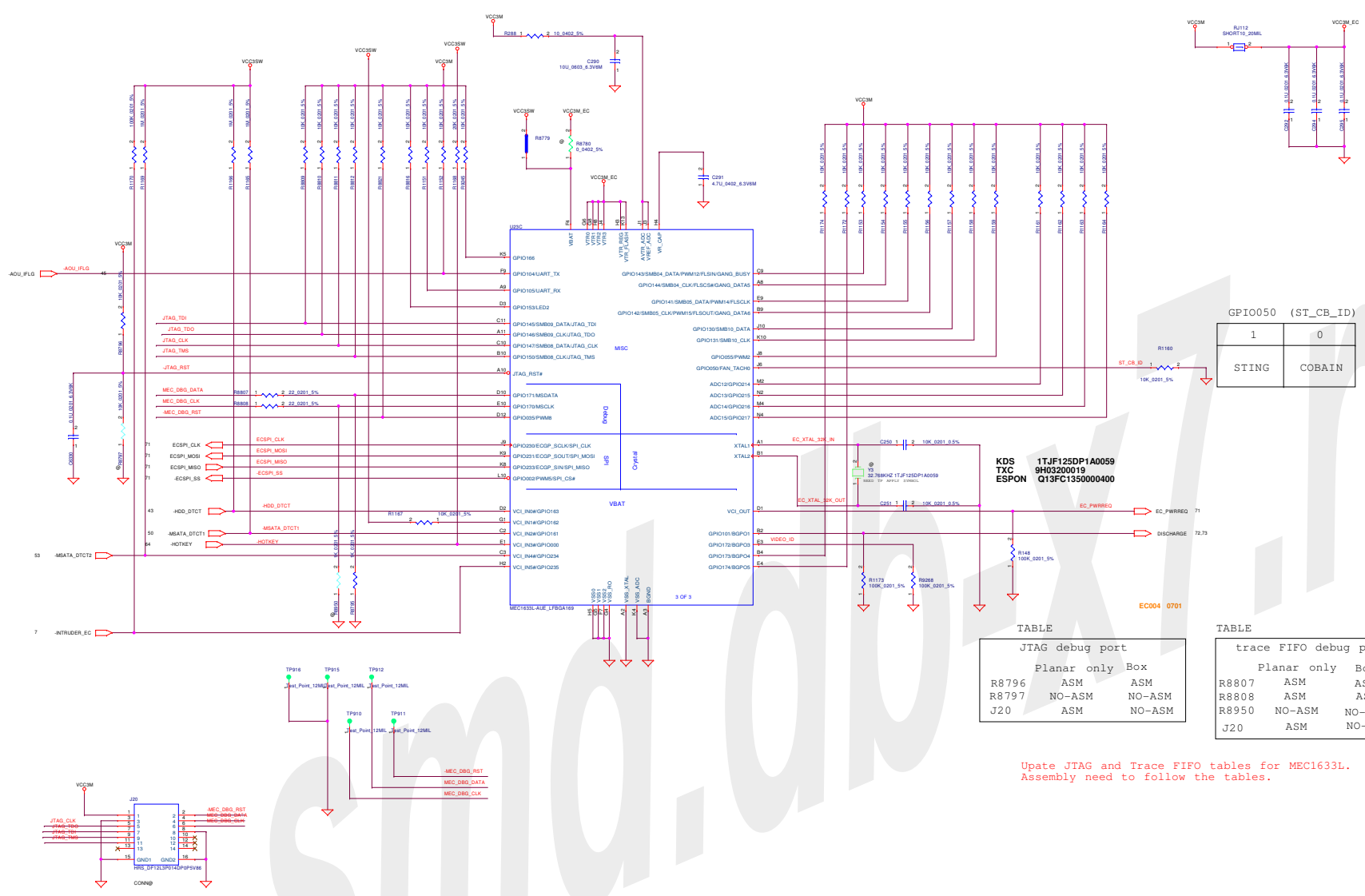

GPIO050 (ST\_CB\_ID)

1	0
STING	COBAIN

KDS  
TXC  
ESPON

1TJF125DP1A0059  
9H0320019  
Q13FC1350000400

TABLE

JTAG debug port

	Planar only	Box
R8796	ASM	ASM
R8797	NO-ASM	NO-ASM
J20	ASM	NO-ASM

TABLE

trace FIFO debug port

	Planar only	Box
R8807	ASM	ASM
R8808	ASM	ASM
R8950	NO-ASM	NO-ASM
J20	ASM	NO-ASM

Update JTAG and Trace FIFO tables for MEC1633L.  
Assembly need to follow the tables.

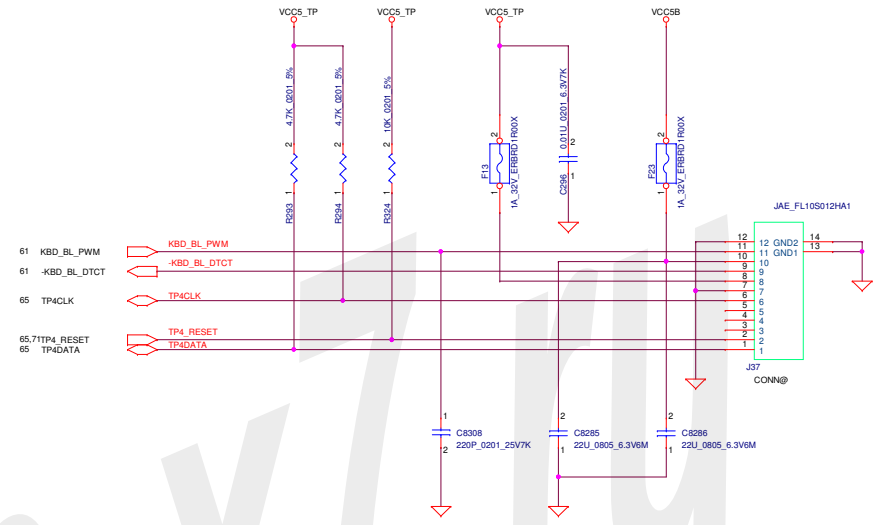
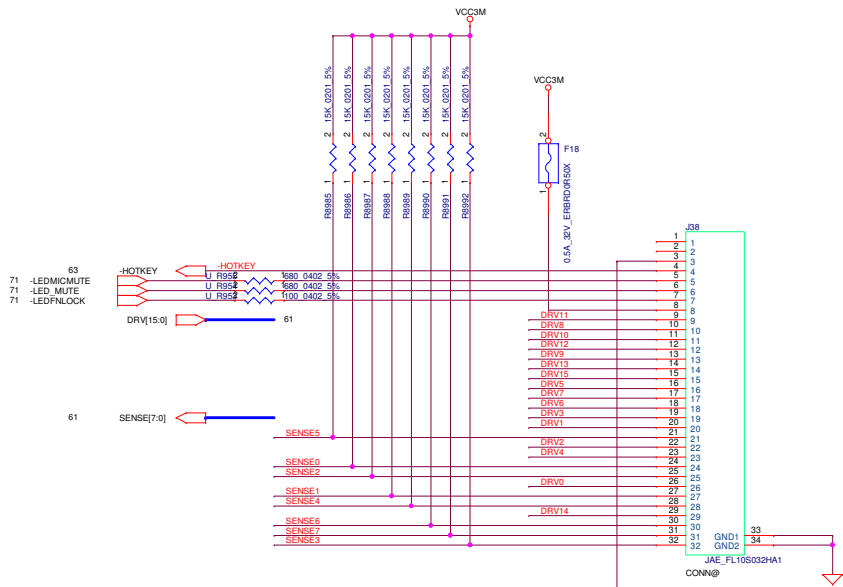

smd.db-X7.114

Security Classification		LC Future Center Secret Data		Title	
Issued Date	2012/05/01	Deciphered Date	2012/12/01	KEYBOARD CONNECTOR	
THIS SHEET OF ENGINEERING DRAWING IS THE PROPRIETARY PROPERTY OF LC FUTURE CENTER, AND CONTAINS CONFIDENTIAL AND TRADE SECRET INFORMATION. THIS SHEET MAY NOT BE TRANSFERRED FROM THE CUSTODY OF THE COMPETENT DIVISION OF RAD DEPARTMENT EXCEPT AS AUTHORIZED BY LC FUTURE CENTER. NEITHER THIS SHEET NOR THE INFORMATION IT CONTAINS MAY BE USED BY OR DISCLOSED TO ANY THIRD PARTY WITHOUT PRIOR WRITTEN CONSENT OF LC FUTURE CENTER.				 <b>COBAT IN UMA</b> Size: Document Number: Rev: 0.1 Date: Thursday, October 23, 2014 Sheet: 64 of 100	

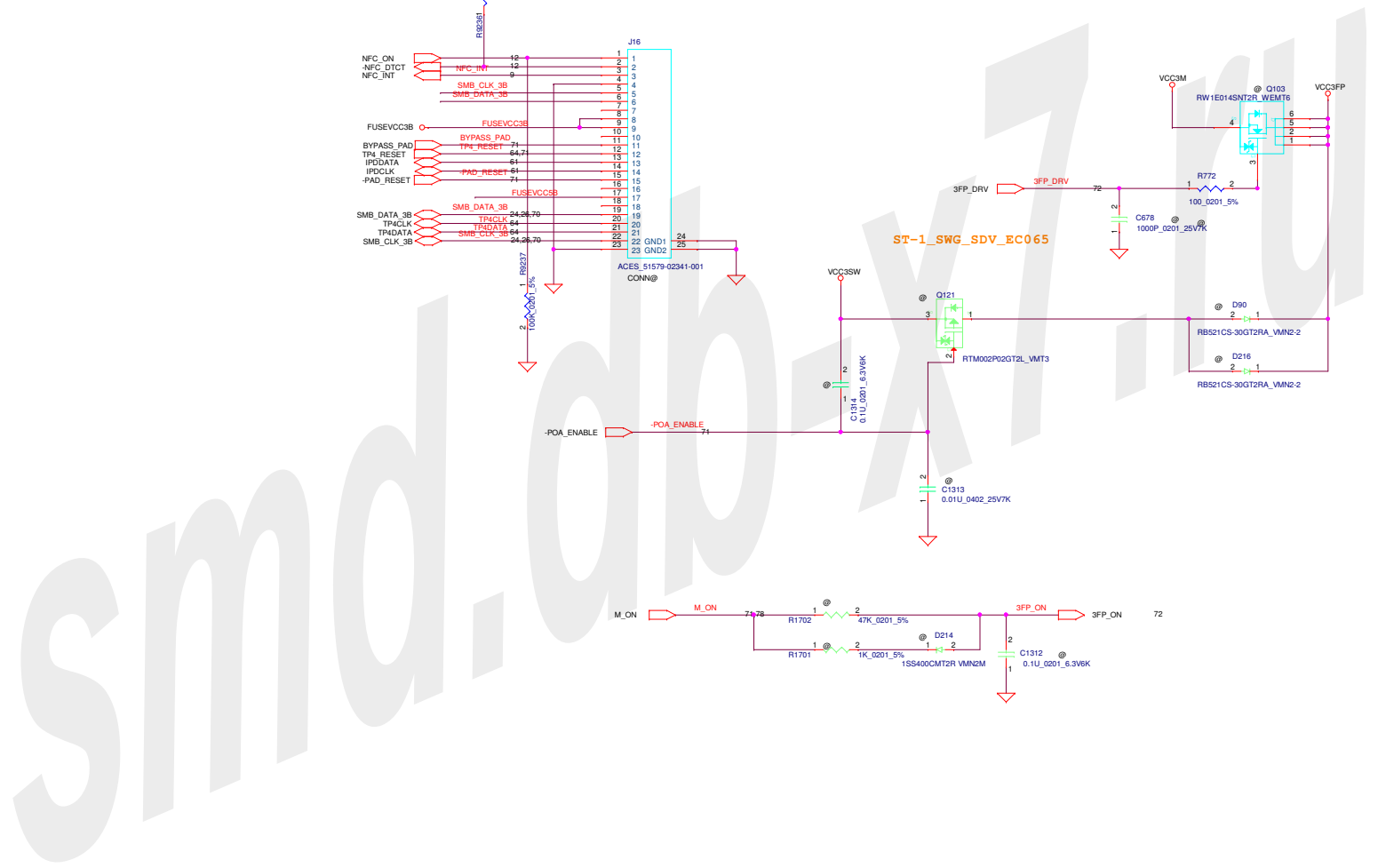
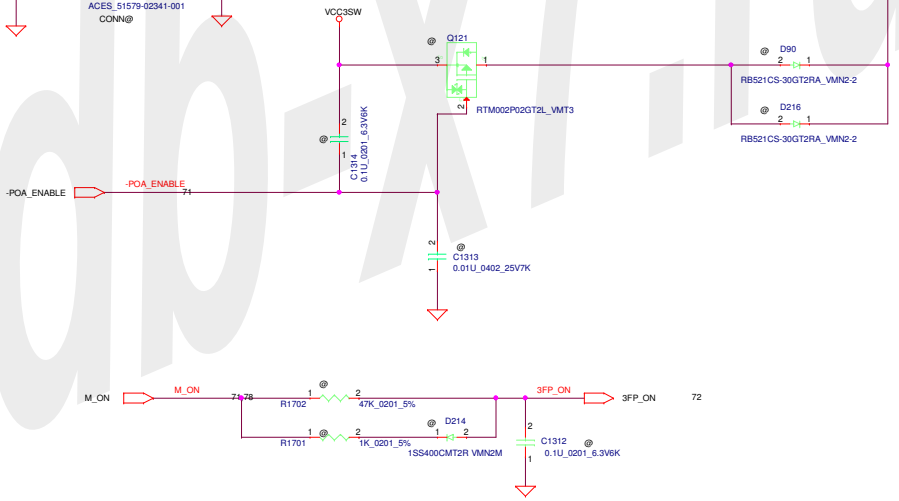
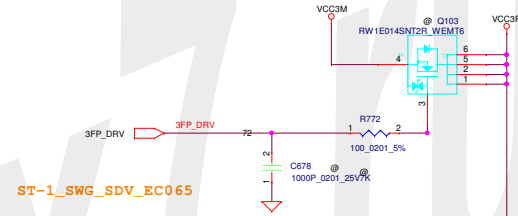
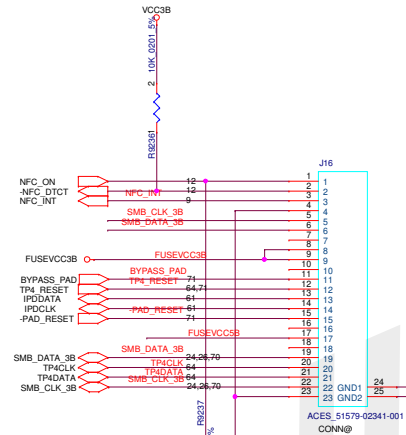
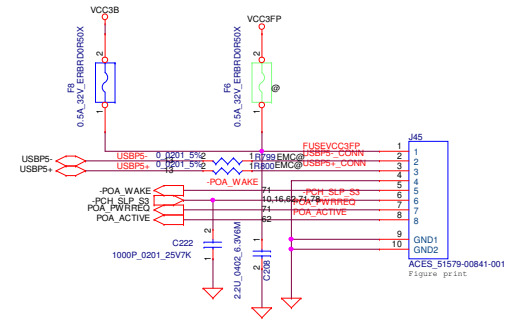
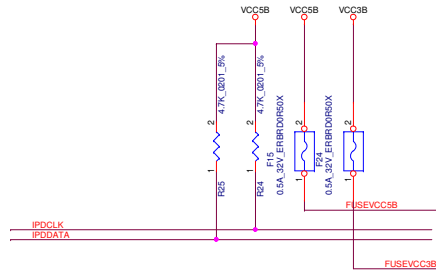

Security Classification	LC Future Center Secret Data		Title
Issued Date	2012/05/02	Deciphered Date	2012/5/02
THIS SHEET OF ENGINEERING DRAWING IS THE PROPRIETARY PROPERTY OF LC FUTURE CENTER, AND CONTAINS CONFIDENTIAL AND TRADE SECRET INFORMATION. THIS SHEET MAY NOT BE TRANSFERRED FROM THE CUSTODY OF THE COMPETENT DIVISION OF R&D DEPARTMENT EXCEPT AS AUTHORIZED BY LC FUTURE CENTER. NEITHER THIS SHEET NOR THE INFORMATION IT CONTAINS MAY BE USED BY OR DISCLOSED TO ANY THIRD PARTY WITHOUT PRIOR WRITTEN CONSENT OF LC FUTURE CENTER.			
Size	Document Number	Rev	
	COBRA IN UTM	01	
Date:	Thursday, October 23, 2014	Sheet	65 of 100

BLANK

smd.db-x7.ru

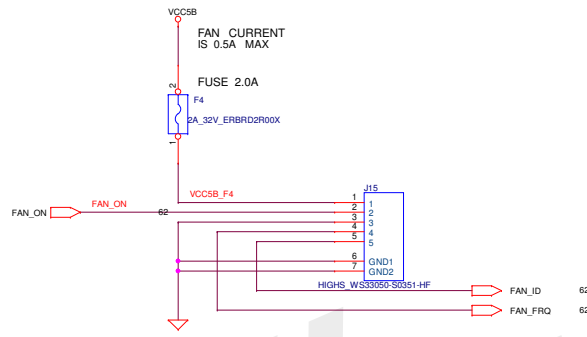

smd.db-x7.ru

Security Classification	LC Future Center Secret Data		Title	
Issued Date	2012/05/02	Deciphered Date	2012/5/02	
<small>THIS SHEET OF ENGINEERING DRAWING IS THE PROPRIETARY PROPERTY OF LC FUTURE CENTER, AND CONTAINS CONFIDENTIAL AND TRADE SECRET INFORMATION. THIS SHEET MAY NOT BE TRANSFERRED FROM THE CUSTODY OF THE COMPETENT DIVISION OF R&amp;D DEPARTMENT EXCEPT AS AUTHORIZED BY LC FUTURE CENTER. NEITHER THIS SHEET NOR THE INFORMATION IT CONTAINS MAY BE USED BY OR DISCLOSED TO ANY THIRD PARTY WITHOUT PRIOR WRITTEN CONSENT OF LC FUTURE CENTER.</small>				Size Document Number Customer <b>COBA IN UMA</b> Rev 0.1
Date: Thursday, October 23, 2014				Sheet 07 of 100

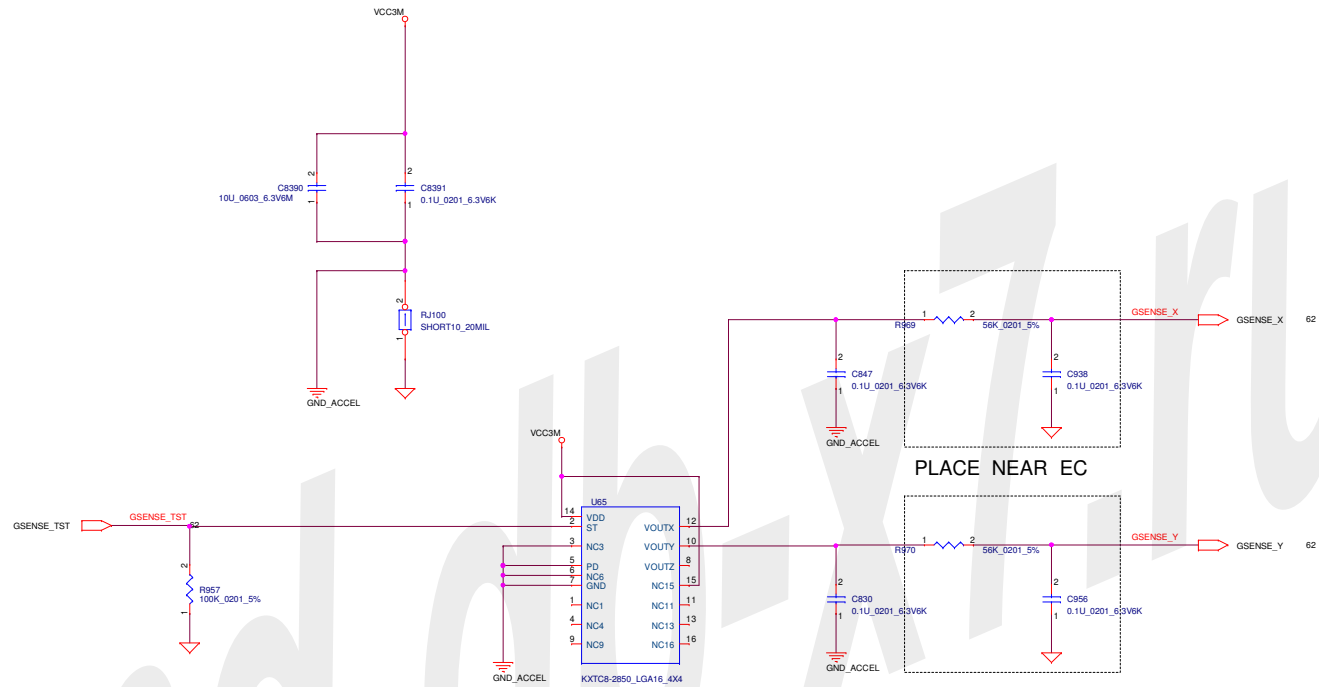

TABLE

	LIS34AL KXTC8-2850	NO ACC.
R401 R957	NO_ASM ASM	ASM ASM
U65 Q105	ASM ASM	NO_ASM NO_ASM
R885 C829 C959	10-OHM ASM ASM	NO_ASM NO_ASM NO_ASM
C830 C847	ASM ASM	NO_ASM NO_ASM
R969 C938 R970 C956	56K ASM 56K ASM	NO_ASM NO_ASM NO_ASM NO_ASM
C704 R344 C703	NO_ASM NO_ASM NO_ASM	NO_ASM NO_ASM NO_ASM
R125	ASM	ASM

LOGIC  
↓

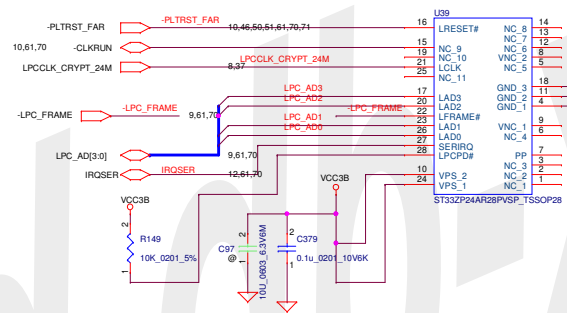

Security Classification		LC Future Center Secret Data		Title	
Issued Date	2012/05/02	Deciphered Date	2012/5/02	TPM	
THIS SHEET OF ENGINEERING DRAWING IS THE PROPRIETARY PROPERTY OF LC FUTURE CENTER, AND CONTAINS CONFIDENTIAL AND TRADE SECRET INFORMATION. THIS SHEET MAY NOT BE TRANSFERRED FROM THE CUSTODY OF THE COMPETENT DIVISION OF R&D DEPARTMENT EXCEPT AS AUTHORIZED BY LC FUTURE CENTER. NEITHER THIS SHEET NOR THE INFORMATION IT CONTAINS MAY BE USED BY OR DISCLOSED TO ANY THIRD PARTY WITHOUT PRIOR WRITTEN CONSENT OF LC FUTURE CENTER.					
Size	Document Number	COBA IN UMA		Rev 0.1	
Date:	Thursday, October 23, 2014	Sheet	99	of 100	

TABLE

EEPROM	U22	U23
U22	ASM	NO_ASM
C1005	ASM	NO_ASM
R577	ASM	NO_ASM
Q97	ASM	NO_ASM

Update the table for LPC debug port

LPC Debug Port		
J5	ASM	NO_ASM
R9062	ASM	ASM

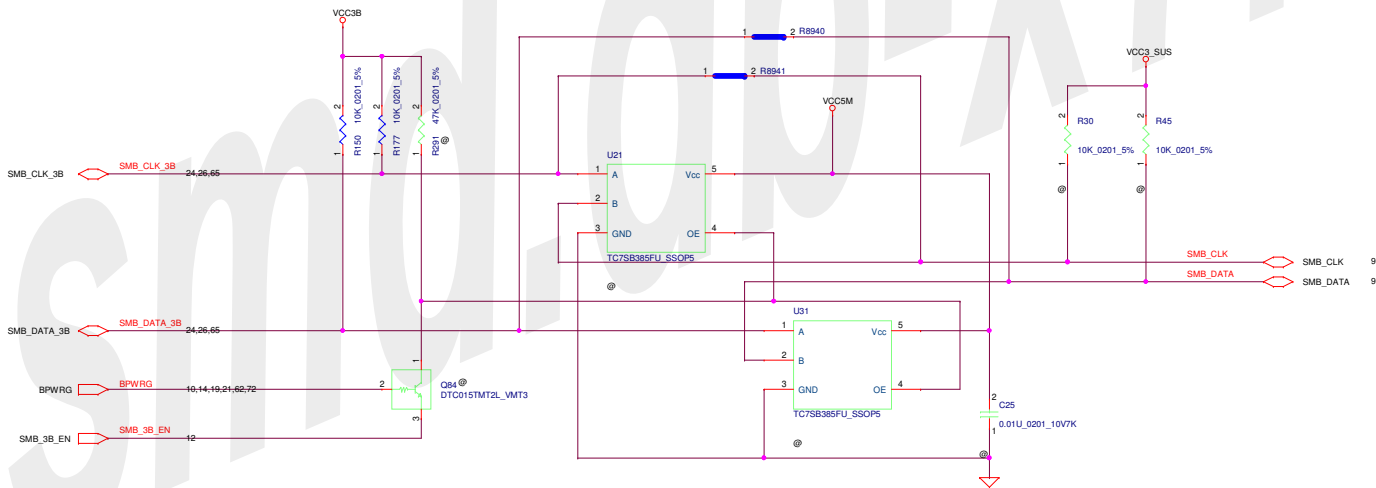
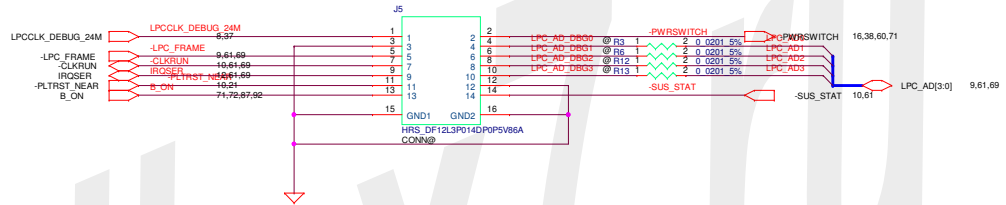
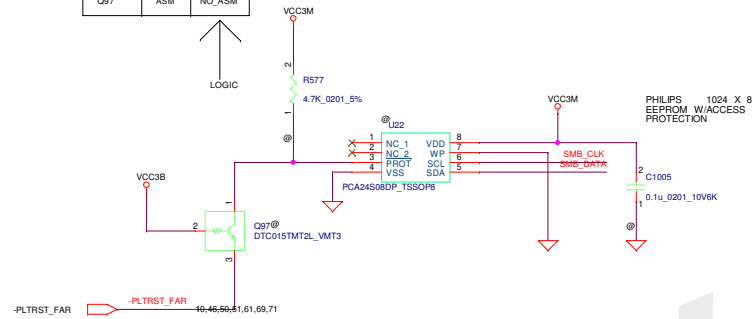

TABLE

EEPROM	U22	U23
U21	ASM	NO_ASM
U31	ASM	NO_ASM
C25	ASM	NO_ASM
R291	ASM	NO_ASM
Q84	ASM	NO_ASM
R8941	NO_ASM	ASM
R8940	NO_ASM	ASM
R30	ASM	NO_ASM
R45	ASM	NO_ASM

↑  
LOGIC

Security Classification	LC Future Center Secret Data		Title
Issued Date	2012/05/02	Deciphered Date	2012/5/02
THIS SHEET OF ENGINEERING DRAWING IS THE PROPRIETARY PROPERTY OF LC FUTURE CENTER, AND CONTAINS CONFIDENTIAL AND TRADE SECRET INFORMATION. THIS SHEET MAY NOT BE TRANSFERRED FROM THE CUSTODY OF THE COMPETENT DIVISION OF RAD DEPARTMENT EXCEPT AS AUTHORIZED BY LC FUTURE CENTER. NEITHER THIS SHEET NOR THE INFORMATION IT CONTAINS MAY BE USED BY OR DISCLOSED TO ANY THIRD PARTY WITHOUT PRIOR WRITTEN CONSENT OF LC FUTURE CENTER.			
Size	Document Number	Rev	
Sheet	CORA IN UMA	01	
Date:	Thursday, October 23, 2014	Sheet	70 of 100



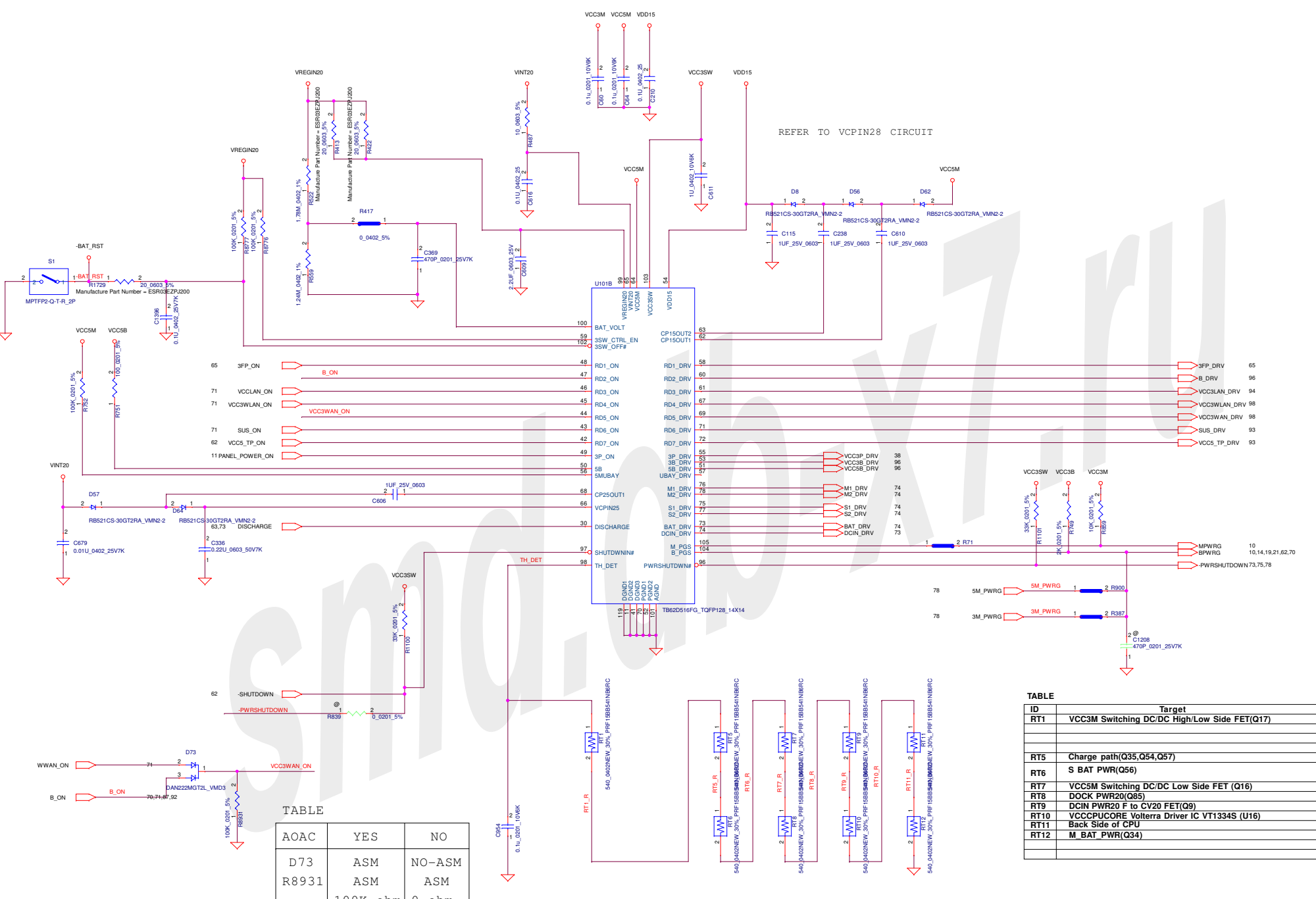

REFER TO VCPIN28 CIRCUIT

TABLE

AOAC	YES	NO
D73	ASM	NO-ASM
R8931	ASM	ASM
	100K-ohm	0-ohm

LOGIC

TABLE

ID	Target
RT1	VCC3M Switching DC/DC High/Low Side FET(Q17)
RT5	Charge path(Q35,Q54,Q57)
RT6	S BAT PWR(Q56)
RT7	VCC5M Switching DC/DC Low Side FET (Q16)
RT8	DOCK PWR20(Q85)
RT9	DOCK PWR20 F to CV20 FET(Q9)
RT10	VCC5M PUCORE Voltterra Driver IC VT1334S (U16)
RT11	Back Side of CPl
RT12	M_BAT PWR(Q34)

Security Classification	LC Future Center Secret Data		Title	THINK ENGINE(2/2)
Issued Date	2012/07/01	Deciphered Date	2014/07/01	Size
THIS SHEET OF ENGINEERING DRAWING IS THE PROPRIETARY PROPERTY OF LC FUTURE CENTER, AND CONTAINS CONFIDENTIAL AND TRADE SECRET INFORMATION. THIS SHEET MAY NOT BE TRANSFERRED FROM THE CUSTODY OF THE COMPETENT DIVISION OF R&D DEPARTMENT EXCEPT AS AUTHORIZED BY LC FUTURE CENTER. NEITHER THIS SHEET NOR THE INFORMATION IT CONTAINS MAY BE USED BY OR DISCLOSED TO ANY THIRD PARTY WITHOUT PRIOR WRITTEN CONSENT OF LC FUTURE CENTER.				Document Number
				Rev
				01
				Date: Thursday, October 23, 2014 Sheet 72 of 100



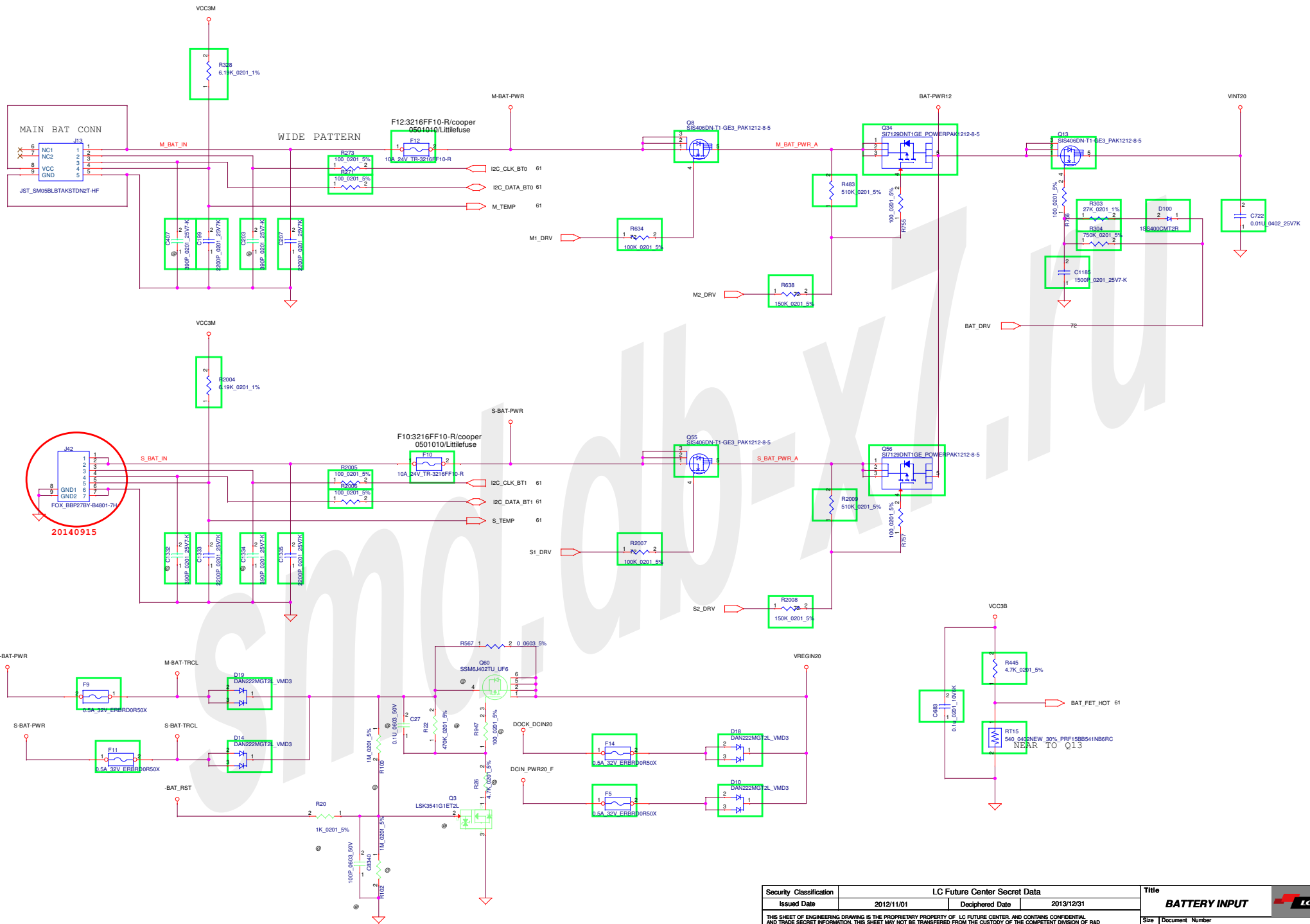



20140915

Security Classification	LC Future Center Secret Data		Title	 <b>BATTERY INPUT</b>
Issued Date	2012/11/01	Deciphered Date	2013/12/31	
<small>THIS SHEET OF ENGINEERING DRAWING IS THE PROPRIETARY PROPERTY OF LC FUTURE CENTER, AND CONTAINS CONFIDENTIAL AND TRADE SECRET INFORMATION. THIS SHEET MAY NOT BE TRANSFERRED FROM THE CUSTODY OF THE COMPETENT DIVISION OF R&amp;D DEPARTMENT EXCEPT AS AUTHORIZED BY LC FUTURE CENTER. NEITHER THIS SHEET NOR THE INFORMATION IT CONTAINS MAY BE USED BY OR DISCLOSED TO ANY THIRD PARTY WITHOUT PRIOR WRITTEN CONSENT OF LC FUTURE CENTER.</small>				Size: Document Number <b>Sting UMA</b> Date: Thursday, October 23, 2014 Sheet 74 of 100



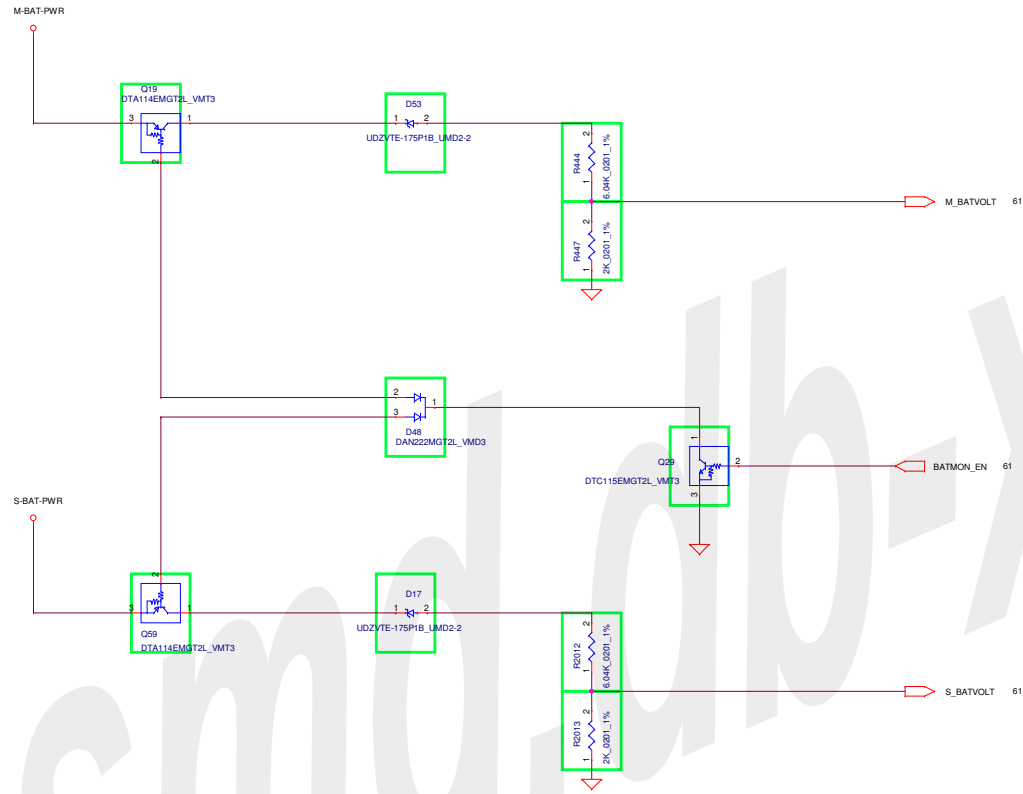





Security Classification	LC Future Center Secret Data		Title	
Issued Date	2012/11/01	Deciphered Date	2013/12/31	
<small>THIS SHEET OF ENGINEERING DRAWING IS THE PROPRIETARY PROPERTY OF LC FUTURE CENTER, AND CONTAINS CONFIDENTIAL AND TRADE SECRET INFORMATION. THIS SHEET MAY NOT BE TRANSFERRED FROM THE CUSTODY OF THE COMPETENT DIVISION OF R&amp;D DEPARTMENT EXCEPT AS AUTHORIZED BY LC FUTURE CENTER. NEITHER THIS SHEET NOR THE INFORMATION IT CONTAINS MAY BE USED BY OR DISCLOSED TO ANY THIRD PARTY WITHOUT PRIOR WRITTEN CONSENT OF LC FUTURE CENTER.</small>				Size: 0.1 Document Number: Sting UMA Date: Thursday, October 23, 2014 Sheet 77 of 100



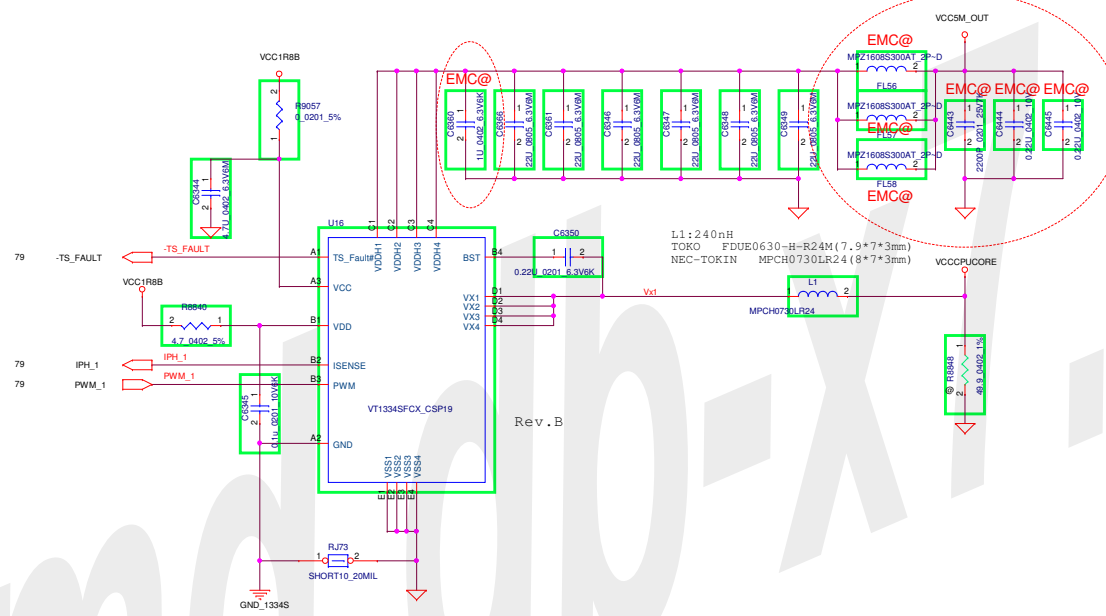



Security Classification	LC Future Center Secret Data		Title	 <b>DC/DC VCCCPUCORE(VT1334S)</b>
Issued Date	2012/11/01	Deciphered Date	2013/12/31	
<small>THIS SHEET OF ENGINEERING DRAWING IS THE PROPRIETARY PROPERTY OF LC FUTURE CENTER, AND CONTAINS CONFIDENTIAL AND TRADE SECRET INFORMATION. THIS SHEET MAY NOT BE TRANSFERRED FROM THE CUSTODY OF THE COMPETENT DIVISION OF RAD DEPARTMENT EXCEPT AS AUTHORIZED BY LC FUTURE CENTER. NEITHER THIS SHEET NOR THE INFORMATION IT CONTAINS MAY BE USED BY OR DISCLOSED TO ANY THIRD PARTY WITHOUT PRIOR WRITTEN CONSENT OF LC FUTURE CENTER.</small>				Size Document Number Customer <b>Sting UMA</b> Date: Thursday, October 23, 2014 Sheet 80 of 100

BLANK

smd.dlp-x7.ru

Security Classification	LC Future Center Secret Data		Title	 <b>BLANK</b>
Issued Date	2012/11/01	Deciphered Date	2013/12/31	
<small>THIS SHEET OF ENGINEERING DRAWING IS THE PROPRIETARY PROPERTY OF LC FUTURE CENTER, AND CONTAINS CONFIDENTIAL AND TRADE SECRET INFORMATION. THIS SHEET MAY NOT BE TRANSFERRED FROM THE CUSTODY OF THE COMPETENT DIVISION OF ROAD DEPARTMENT EXCEPT AS AUTHORIZED BY LC FUTURE CENTER. NEITHER THIS SHEET NOR THE INFORMATION IT CONTAINS MAY BE USED BY OR DISCLOSED TO ANY THIRD PARTY WITHOUT PRIOR WRITTEN CONSENT OF LC FUTURE CENTER.</small>				
Size	Document Number	Sting UMA		Rev
Customer				0.24
Date:	Thursday, October 23, 2014		Sheet	81 of 100

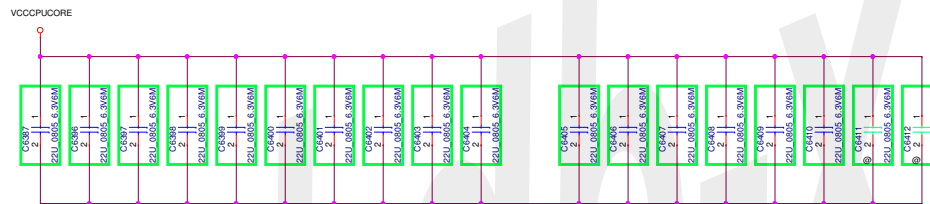

16pcs 22uF for VCCCPUCORE of 25U ULT CPU  
 (14pcs 22uF for VCCCPUCORE of 15U ULT CPU)

Security Classification	LC Future Center Secret Data		Title
Issued Date	2012/11/01	Deciphered Date	2013/12/31
THIS SHEET OF ENGINEERING DRAWING IS THE PROPRIETARY PROPERTY OF LC FUTURE CENTER, AND CONTAINS CONFIDENTIAL AND TRADE SECRET INFORMATION. THIS SHEET MAY NOT BE TRANSFERRED FROM THE CUSTODY OF THE COMPETENT DIVISION OF R&D DEPARTMENT EXCEPT AS AUTHORIZED BY LC FUTURE CENTER. NEITHER THIS SHEET NOR THE INFORMATION IT CONTAINS MAY BE USED BY OR DISCLOSED TO ANY THIRD PARTY WITHOUT PRIOR WRITTEN CONSENT OF LC FUTURE CENTER.			VCCCPUCORE DECOUPLING 
Size	Document Number	Rev	
Customer	Sting UMA	0.24	
Date:	Thursday, October 23, 2014	Sheet	82 of 100

smd.dib-x7.ru

BLANK

Security Classification	LC Future Center Secret Data		Title			
Issued Date	2012/11/01	Deciphered Date	2013/12/31		BLANK	
THIS SHEET OF ENGINEERING DRAWING IS THE PROPRIETARY PROPERTY OF LC FUTURE CENTER, AND CONTAINS CONFIDENTIAL AND TRADE SECRET INFORMATION. THIS SHEET MAY NOT BE TRANSFERRED FROM THE CUSTODY OF THE COMPETENT DIVISION OF ROAD DEPARTMENT EXCEPT AS AUTHORIZED BY LC FUTURE CENTER. NEITHER THIS SHEET NOR THE INFORMATION IT CONTAINS MAY BE USED BY OR DISCLOSED TO ANY THIRD PARTY WITHOUT PRIOR WRITTEN CONSENT OF LC FUTURE CENTER.				Size	Document Number	Rev
				Customer	Sting UMA	0.24
				Date:	Thursday, October 23, 2014	Sheet 83 of 100

smd.dlp-x7.ru

BLANK

Security Classification	LC Future Center Secret Data		Title	 <b>BLANK</b>		
Issued Date	2012/11/01	Deciphered Date	2013/12/31			
<small>THIS SHEET OF ENGINEERING DRAWING IS THE PROPRIETARY PROPERTY OF LC FUTURE CENTER, AND CONTAINS CONFIDENTIAL AND TRADE SECRET INFORMATION. THIS SHEET MAY NOT BE TRANSFERRED FROM THE CUSTODY OF THE COMPETENT DIVISION OF ROAD DEPARTMENT EXCEPT AS AUTHORIZED BY LC FUTURE CENTER. NEITHER THIS SHEET NOR THE INFORMATION IT CONTAINS MAY BE USED BY OR DISCLOSED TO ANY THIRD PARTY WITHOUT PRIOR WRITTEN CONSENT OF LC FUTURE CENTER.</small>				Size Customer	Document Number <b>Sting UMA</b>	Rev 0.24
				Date:	Thursday, October 23, 2014	Sheet 84 of 100

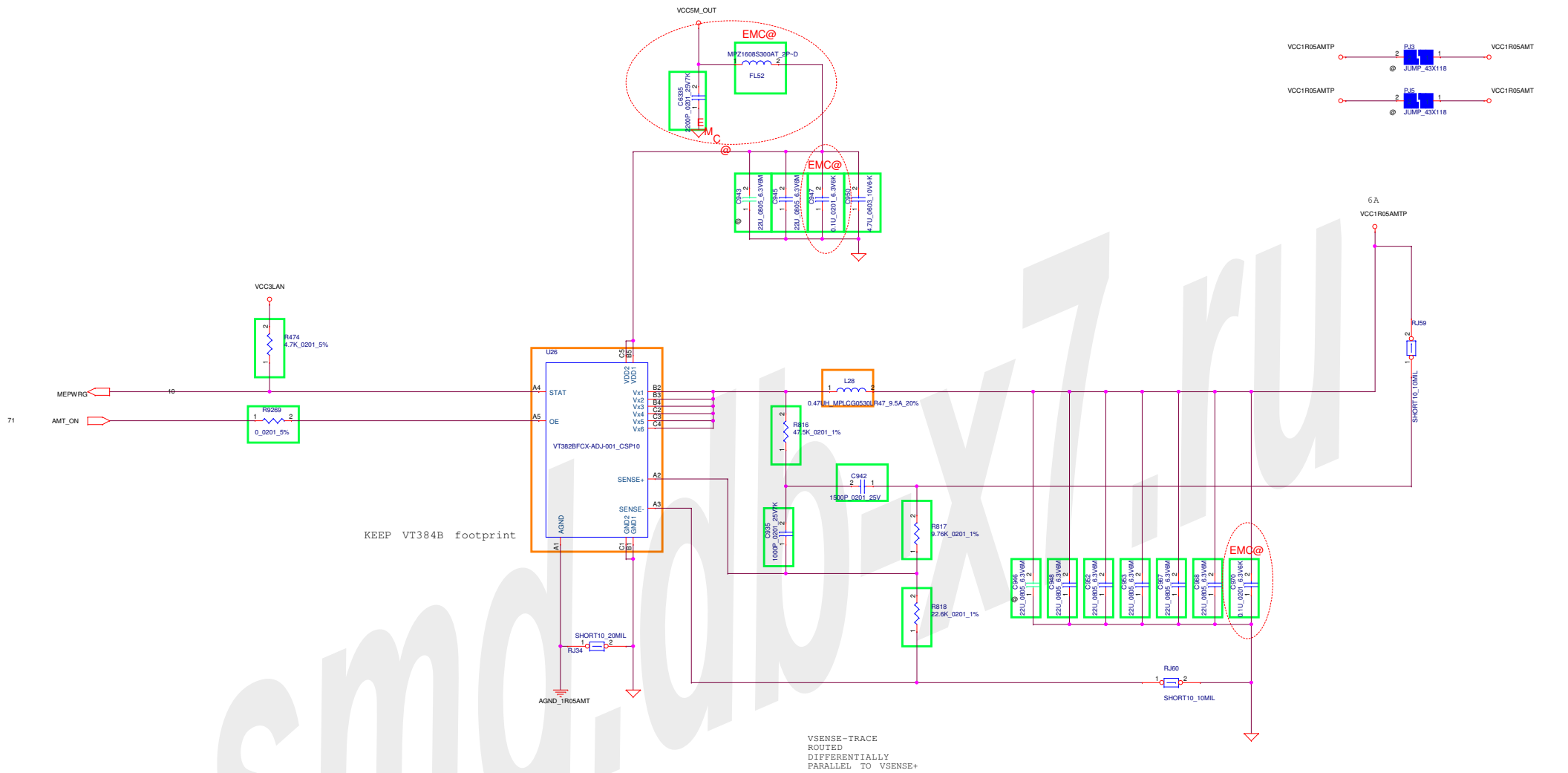

KEEP VT384B footprint

VSENSE-TRACE  
ROUTED  
DIFFERENTIALLY  
PARALLEL TO VSENSE+

$$V_{out} = 0.75 \times (1 + R_{817}/R_{818})$$

Security Classification		LC Future Center Secret Data		Title	
Issued Date	2012/11/01	Deciphered Date	2013/12/31	DC/DC VCC1R05AMT(VT382B)	
THIS SHEET OF ENGINEERING DRAWING IS THE PROPRIETARY PROPERTY OF LC FUTURE CENTER, AND CONTAINS CONFIDENTIAL AND TRADE SECRET INFORMATION. THIS SHEET MAY NOT BE TRANSFERRED FROM THE CUSTODY OF THE COMPETENT DIVISION OF R&D DEPARTMENT EXCEPT AS AUTHORIZED BY LC FUTURE CENTER. NEITHER THIS SHEET NOR THE INFORMATION IT CONTAINS MAY BE USED BY OR DISCLOSED TO ANY THIRD PARTY WITHOUT PRIOR WRITTEN CONSENT OF LC FUTURE CENTER.					
Size	Document Number	Date		Rev	
	Sting UMA	Thursday, October 23, 2014		0.24	
				Sheet 85 of 100	

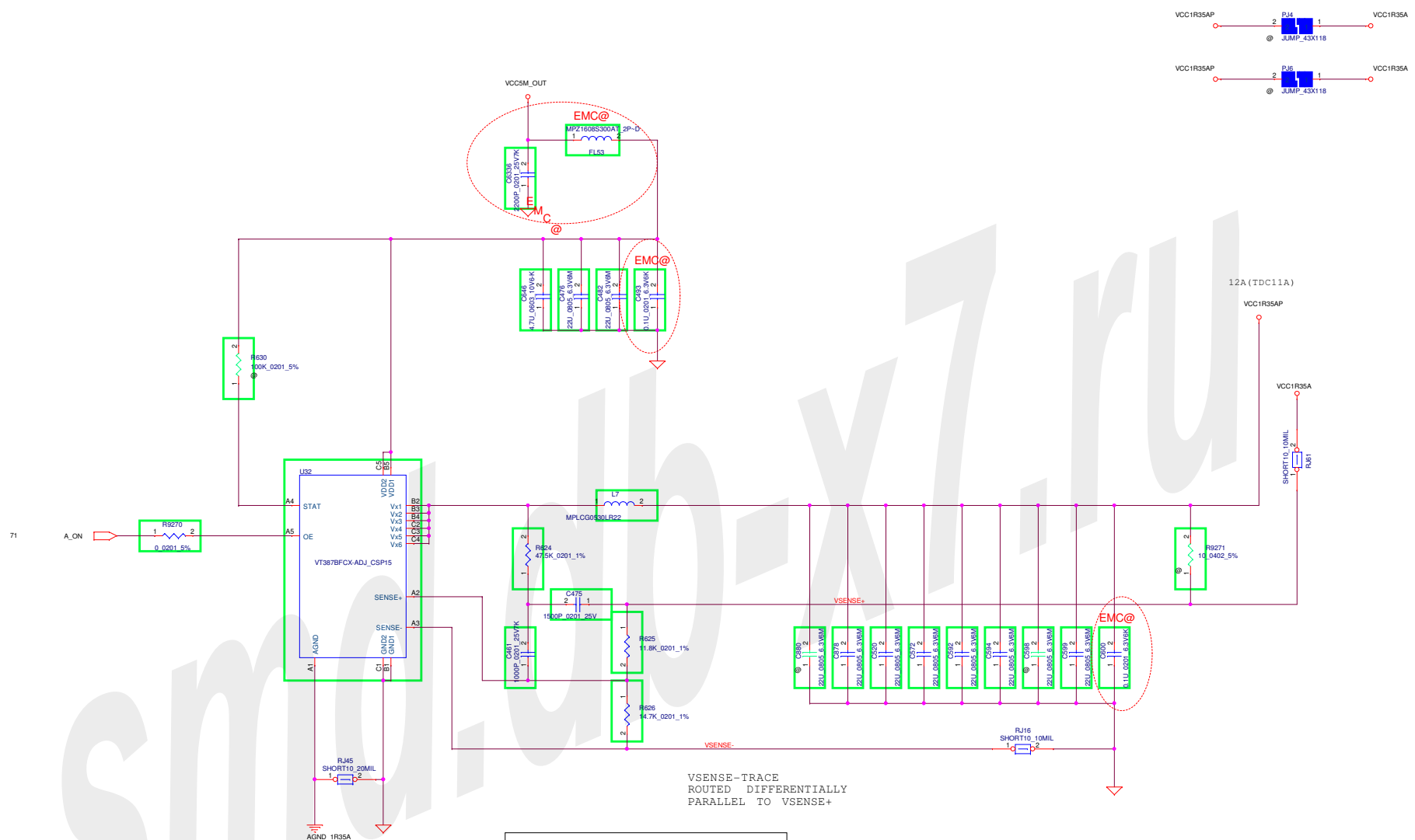

$$V_{out} = 0.75 \times (1 + (R_{F1}/R_{F2}))$$

RF1	RF2
R625	R626
3.65K	4.53K for 1.35V
4.02K	4.02K for 1.50V

VSENSE-TRACE  
ROUTED DIFFERENTIALLY  
PARALLEL TO VSENSE+

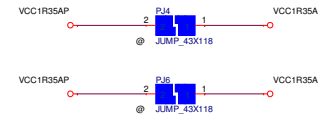

Security Classification	LC Future Center Secret Data		Title
Issued Date	2012/11/01	Deciphered Date	2013/12/31
THIS SHEET OF ENGINEERING DRAWING IS THE PROPRIETARY PROPERTY OF LC FUTURE CENTER, AND CONTAINS CONFIDENTIAL AND TRADE SECRET INFORMATION. THIS SHEET MAY NOT BE TRANSFERRED FROM THE CUSTODY OF THE COMPETENT DIVISION OF R&D DEPARTMENT EXCEPT AS AUTHORIZED BY LC FUTURE CENTER. NEITHER THIS SHEET NOR THE INFORMATION IT CONTAINS MAY BE USED BY OR DISCLOSED TO ANY THIRD PARTY WITHOUT PRIOR WRITTEN CONSENT OF LC FUTURE CENTER.			
Size	Document Number	Rev	
Date:	Thursday, October 23, 2014	Sheet	86 of 100

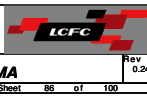

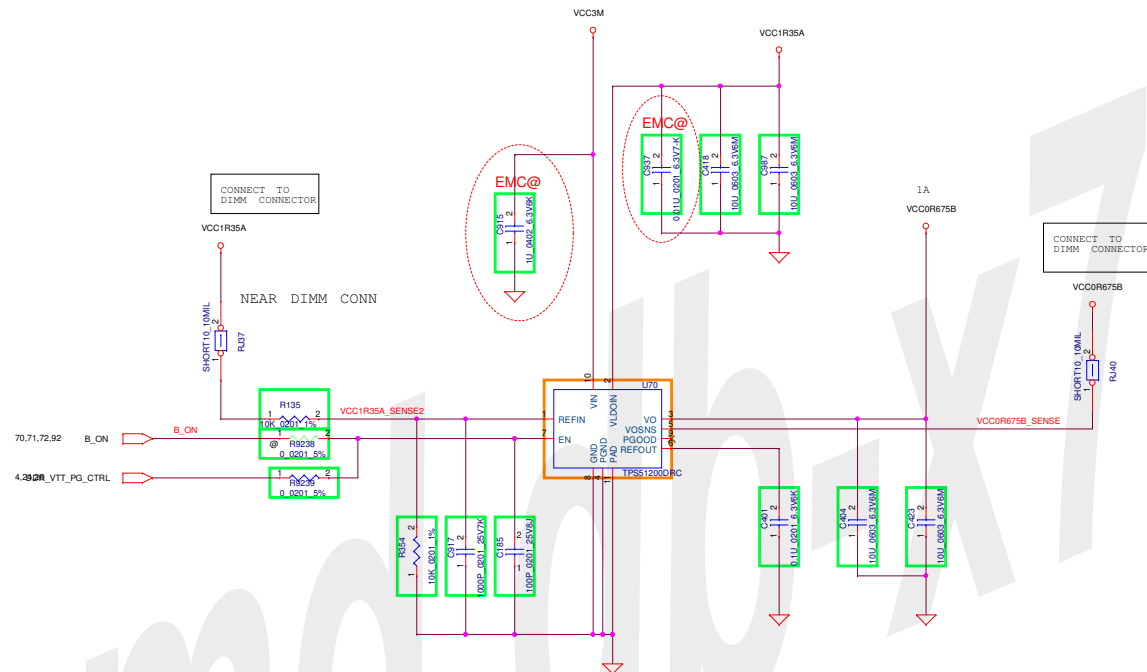

Security Classification	LC Future Center Secret Data		Title
Issued Date	2012/11/01	Deciphered Date	2013/12/31
THIS SHEET OF ENGINEERING DRAWING IS THE PROPRIETARY PROPERTY OF LC FUTURE CENTER, AND CONTAINS CONFIDENTIAL AND TRADE SECRET INFORMATION. THIS SHEET MAY NOT BE TRANSFERRED FROM THE CUSTODY OF THE COMPETENT DIVISION OF R&D DEPARTMENT EXCEPT AS AUTHORIZED BY LC FUTURE CENTER. NEITHER THIS SHEET NOR THE INFORMATION IT CONTAINS MAY BE USED BY OR DISCLOSED TO ANY THIRD PARTY WITHOUT PRIOR WRITTEN CONSENT OF LC FUTURE CENTER.			DC/DC VCC0R675B(TPS51200) 
Size	Document Number	Rev	0.24
Date:	Thursday, October 23, 2014	Sheet	87 of 100

smd.dib-x7.ru

BLANK

Security Classification	LC Future Center Secret Data		Title	 <b>BLANK</b>		
Issued Date	2012/11/01	Deciphered Date	2013/12/31			
<small>THIS SHEET OF ENGINEERING DRAWING IS THE PROPRIETARY PROPERTY OF LC FUTURE CENTER, AND CONTAINS CONFIDENTIAL AND TRADE SECRET INFORMATION. THIS SHEET MAY NOT BE TRANSFERRED FROM THE CUSTODY OF THE COMPETENT DIVISION OF ROAD DEPARTMENT EXCEPT AS AUTHORIZED BY LC FUTURE CENTER. NEITHER THIS SHEET NOR THE INFORMATION IT CONTAINS MAY BE USED BY OR DISCLOSED TO ANY THIRD PARTY WITHOUT PRIOR WRITTEN CONSENT OF LC FUTURE CENTER.</small>				Size Customer	Document Number <b>Sting UMA</b>	Rev 0.24
				Date:	Thursday, October 23, 2014	Sheet 88 of 100

BLANK

smd.dib-x7.ru

Security Classification	LC Future Center Secret Data		Title			
Issued Date	2012/11/01	Deciphered Date	2013/12/31		BLANK	
THIS SHEET OF ENGINEERING DRAWING IS THE PROPRIETARY PROPERTY OF LC FUTURE CENTER, AND CONTAINS CONFIDENTIAL AND TRADE SECRET INFORMATION. THIS SHEET MAY NOT BE TRANSFERRED FROM THE CUSTODY OF THE COMPETENT DIVISION OF ROAD DEPARTMENT EXCEPT AS AUTHORIZED BY LC FUTURE CENTER. NEITHER THIS SHEET NOR THE INFORMATION IT CONTAINS MAY BE USED BY OR DISCLOSED TO ANY THIRD PARTY WITHOUT PRIOR WRITTEN CONSENT OF LC FUTURE CENTER.				Size	Document Number	Rev
				Customer	Sting UMA	0.24
				Date:	Thursday, October 23, 2014	Sheet 89 of 100



smd.dlp-x7.ru

BLANK

Security Classification	LC Future Center Secret Data		Title	
Issued Date	2012/11/01	Deciphered Date	2013/12/31	
<small>THIS SHEET OF ENGINEERING DRAWING IS THE PROPRIETARY PROPERTY OF LC FUTURE CENTER, AND CONTAINS CONFIDENTIAL AND TRADE SECRET INFORMATION. THIS SHEET MAY NOT BE TRANSFERRED FROM THE CUSTODY OF THE COMPETENT DIVISION OF ROAD DEPARTMENT EXCEPT AS AUTHORIZED BY LC FUTURE CENTER. NEITHER THIS SHEET NOR THE INFORMATION IT CONTAINS MAY BE USED BY OR DISCLOSED TO ANY THIRD PARTY WITHOUT PRIOR WRITTEN CONSENT OF LC FUTURE CENTER.</small>				
Size	Document Number	Rev	Sting UMA	
Customer		0.24		
Date:	Thursday, October 23, 2014		Sheet	90 of 100



smd.dlp-x7.ru

BLANK

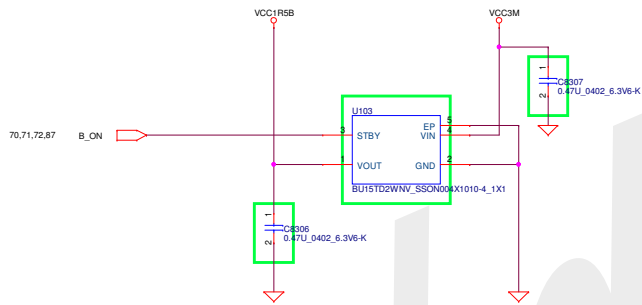
Security Classification	LC Future Center Secret Data		Title	 <b>BLANK</b>
Issued Date	2012/11/01	Deciphered Date	2013/12/31	
<small>THIS SHEET OF ENGINEERING DRAWING IS THE PROPRIETARY PROPERTY OF LC FUTURE CENTER, AND CONTAINS CONFIDENTIAL AND TRADE SECRET INFORMATION. THIS SHEET MAY NOT BE TRANSFERRED FROM THE CUSTODY OF THE COMPETENT DIVISION OF R&amp;D DEPARTMENT EXCEPT AS AUTHORIZED BY LC FUTURE CENTER. NEITHER THIS SHEET NOR THE INFORMATION IT CONTAINS MAY BE USED BY OR DISCLOSED TO ANY THIRD PARTY WITHOUT PRIOR WRITTEN CONSENT OF LC FUTURE CENTER.</small>				
Size	Document Number	Rev	 0.24	
Date:	Thursday, October 23, 2014	Sheet	91	of 100



smd.db-x7.ru

Security Classification	LC Future Center Secret Data		Title
Issued Date	2012/11/01	Deciphered Date	2013/12/31
THIS SHEET OF ENGINEERING DRAWING IS THE PROPRIETARY PROPERTY OF LC FUTURE CENTER, AND CONTAINS CONFIDENTIAL AND TRADE SECRET INFORMATION. THIS SHEET MAY NOT BE TRANSFERRED FROM THE CUSTODY OF THE COMPETENT DIVISION OF R&D DEPARTMENT EXCEPT AS AUTHORIZED BY LC FUTURE CENTER. NEITHER THIS SHEET NOR THE INFORMATION IT CONTAINS MAY BE USED BY OR DISCLOSED TO ANY THIRD PARTY WITHOUT PRIOR WRITTEN CONSENT OF LC FUTURE CENTER.			DC/DC VCC1R5B(BU15TD2WNV) 
Size	Document Number	Rev	0.24
Date:	Thursday, October 23, 2014	Sheet	92 of 100
			

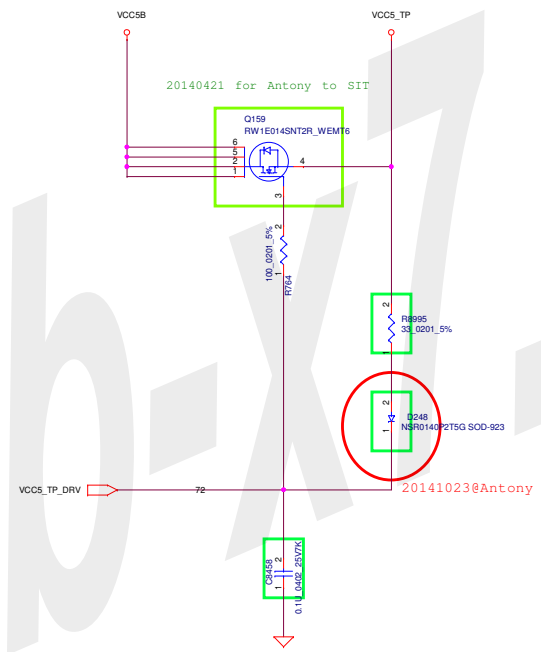
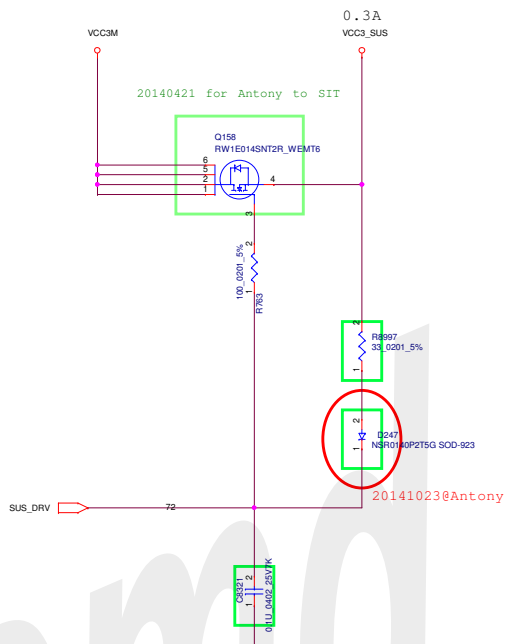

Security Classification	LC Future Center Secret Data		Title	 <b>LOAD SW PCH SUS</b>
Issued Date	2012/11/01	Deciphered Date	2013/12/31	
<small>THIS SHEET OF ENGINEERING DRAWING IS THE PROPRIETARY PROPERTY OF LC FUTURE CENTER, AND CONTAINS CONFIDENTIAL AND TRADE SECRET INFORMATION. THIS SHEET MAY NOT BE TRANSFERRED FROM THE CUSTODY OF THE COMPETENT DIVISION OF R&amp;D DEPARTMENT EXCEPT AS AUTHORIZED BY LC FUTURE CENTER. NEITHER THIS SHEET NOR THE INFORMATION IT CONTAINS MAY BE USED BY OR DISCLOSED TO ANY THIRD PARTY WITHOUT PRIOR WRITTEN CONSENT OF LC FUTURE CENTER.</small>				Size: Document Number Customer: <b>Sting UMA</b> Date: Thursday, October 23, 2014 (Sheet 93 of 100)
				Rev 0.24

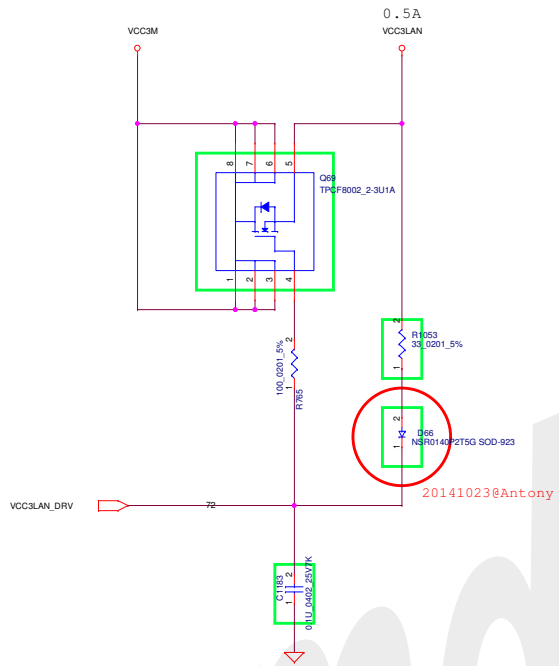

smd.db-x7.ru

Security Classification	LC Future Center Secret Data		Title	 <b>LOAD SW LAN</b>
Issued Date	2012/11/01	Deciphered Date	2013/12/31	
<small>THIS SHEET OF ENGINEERING DRAWING IS THE PROPRIETARY PROPERTY OF LC FUTURE CENTER, AND CONTAINS CONFIDENTIAL AND TRADE SECRET INFORMATION. THIS SHEET MAY NOT BE TRANSFERRED FROM THE CUSTODY OF THE COMPETENT DIVISION OF R&amp;D DEPARTMENT EXCEPT AS AUTHORIZED BY LC FUTURE CENTER. NEITHER THIS SHEET NOR THE INFORMATION IT CONTAINS MAY BE USED BY OR DISCLOSED TO ANY THIRD PARTY WITHOUT PRIOR WRITTEN CONSENT OF LC FUTURE CENTER.</small>				Size Document Number Customer <b>Sting UMA</b> Rev 0.24
Date: Thursday, October 23, 2014				Sheet 94 of 100

BLANK

smd.dlp-x7.ru

Security Classification	LC Future Center Secret Data		Title			
Issued Date	2012/11/01	Deciphered Date	2013/12/31		<b>BLANK</b>	
THIS SHEET OF ENGINEERING DRAWING IS THE PROPRIETARY PROPERTY OF LC FUTURE CENTER, AND CONTAINS CONFIDENTIAL AND TRADE SECRET INFORMATION. THIS SHEET MAY NOT BE TRANSFERRED FROM THE CUSTODY OF THE COMPETENT DIVISION OF ROAD DEPARTMENT EXCEPT AS AUTHORIZED BY LC FUTURE CENTER. NEITHER THIS SHEET NOR THE INFORMATION IT CONTAINS MAY BE USED BY OR DISCLOSED TO ANY THIRD PARTY WITHOUT PRIOR WRITTEN CONSENT OF LC FUTURE CENTER.				Size	Document Number	Rev
				Customer	<b>Sting UMA</b>	0.24
				Date:	Thursday, October 23, 2014	Sheet 95 of 100

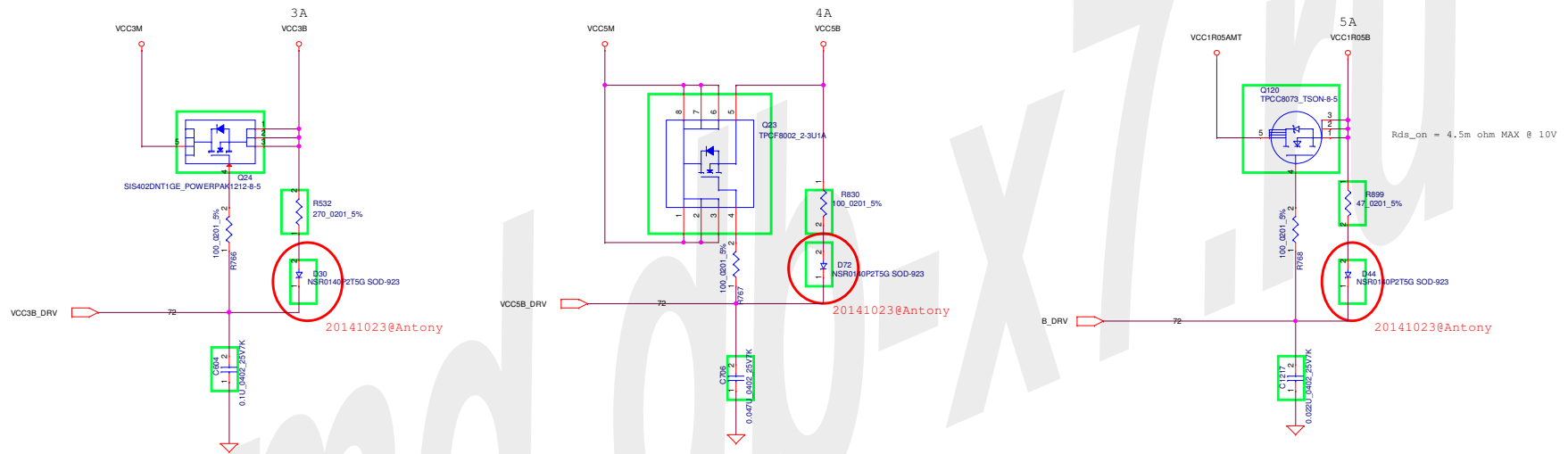

20141023@Antony

20141023@Antony



20141023@Antony

$R_{da\_on} = 4.5m \text{ ohm MAX @ } 10V$

Security Classification	LC Future Center Secret Data		Title
Issued Date	2012/11/01	Deciphered Date	2013/12/31
THIS SHEET OF ENGINEERING DRAWING IS THE PROPRIETARY PROPERTY OF LC FUTURE CENTER, AND CONTAINS CONFIDENTIAL AND TRADE SECRET INFORMATION. THIS SHEET MAY NOT BE TRANSFERRED FROM THE CUSTODY OF THE COMPETENT DIVISION OF R&D DEPARTMENT EXCEPT AS AUTHORIZED BY LC FUTURE CENTER. NEITHER THIS SHEET NOR THE INFORMATION IT CONTAINS MAY BE USED BY OR DISCLOSED TO ANY THIRD PARTY WITHOUT PRIOR WRITTEN CONSENT OF LC FUTURE CENTER.			<b>LOAD SW B</b>  Size: Document Number Customer: <b>Sting UMA</b> Rev: 0.24 Date: Thursday, October 23, 2014 Sheet: 99 of 100

BLANK

smd.dlp-x7.ru

Security Classification	LC Future Center Secret Data		Title	 <b>BLANK</b>
Issued Date	2012/11/01	Deciphered Date	2013/12/31	
<small>THIS SHEET OF ENGINEERING DRAWING IS THE PROPRIETARY PROPERTY OF LC FUTURE CENTER, AND CONTAINS CONFIDENTIAL AND TRADE SECRET INFORMATION. THIS SHEET MAY NOT BE TRANSFERRED FROM THE CUSTODY OF THE COMPETENT DIVISION OF ROAD DEPARTMENT EXCEPT AS AUTHORIZED BY LC FUTURE CENTER. NEITHER THIS SHEET NOR THE INFORMATION IT CONTAINS MAY BE USED BY OR DISCLOSED TO ANY THIRD PARTY WITHOUT PRIOR WRITTEN CONSENT OF LC FUTURE CENTER.</small>				
Size	Document Number	Rev	 0.24	
Date:	Thursday, October 23, 2014	Sheet	97	of 100

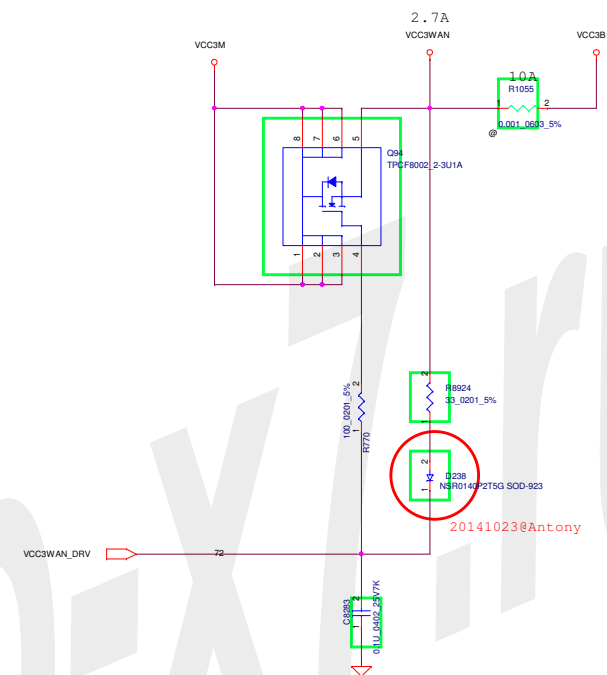
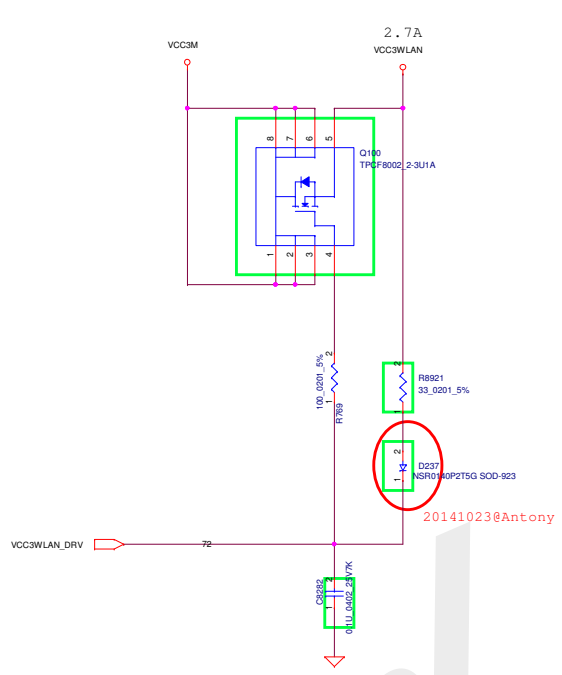

TABLE

AOAC	YES	NO
R1055	NO-ASM	ASM
Q94	ASM	NO-ASM
R8924	ASM	NO-ASM
R8926	ASM	NO-ASM
C8283	ASM	NO-ASM
D238	ASM	NO-ASM

↑  
LOGIC

smd.db-XTRN

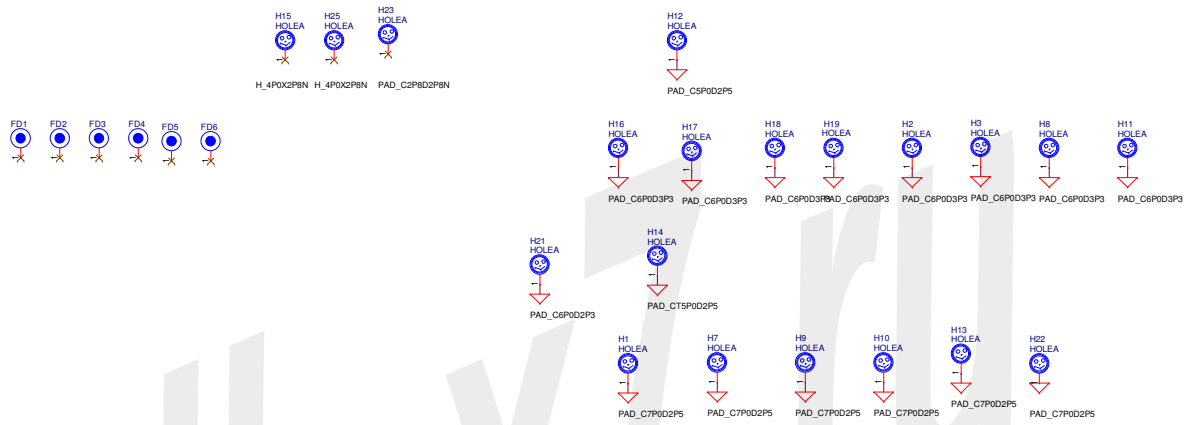

<b>lenovo</b>		
Project Name: C65AN.MX	Title: PTH FOR SCREW HOLES	
Size: C	Document Number: -	Rev: 0.1
Date: Thursday, October 23, 2014	Sheet: 99	of 100

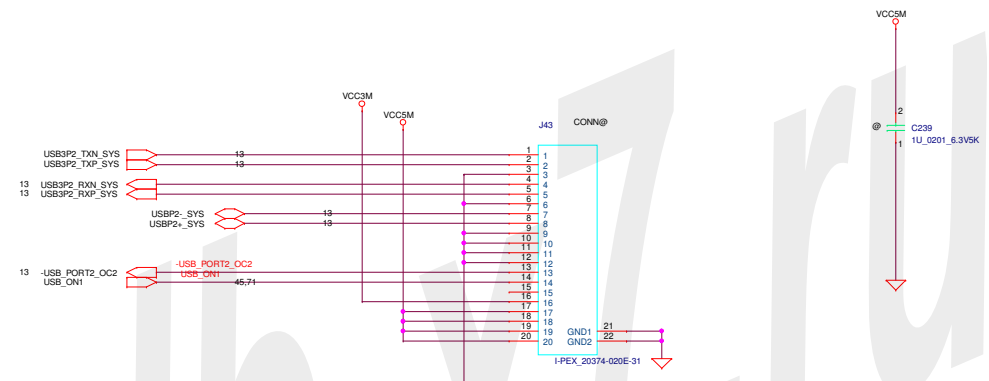

smd.dfb-X7.ru

Security Classification	LC Future Center Secret Data		Title	 <b>3rd USB CONN</b>
Issued Date	2012/11/01	Deciphered Date	2013/12/31	
<small>THIS SHEET OF ENGINEERING DRAWING IS THE PROPRIETARY PROPERTY OF LC FUTURE CENTER, AND CONTAINS CONFIDENTIAL AND TRADE SECRET INFORMATION. THIS SHEET MAY NOT BE TRANSFERRED FROM THE CUSTODY OF THE COMPETENT DIVISION OF R&amp;D DEPARTMENT EXCEPT AS AUTHORIZED BY LC FUTURE CENTER. NEITHER THIS SHEET NOR THE INFORMATION IT CONTAINS MAY BE USED BY OR DISCLOSED TO ANY THIRD PARTY WITHOUT PRIOR WRITTEN CONSENT OF LC FUTURE CENTER.</small>				Size Document Number Customer <b>CORAIN SVG</b> Rev 0.24 Date: Thursday, October 23, 2014 Sheet 100 of 100